

RETURN BIDS TO:
RETOURNER LES SOUMISSIONS À:
Public Works and Government Services Canada
ATB Place North Tower
10025 Jasper Ave./10025 ave. Jaspe
5th floor/5e étage
Edmonton
Alberta
T5J 1S6
Bid Fax: (780) 497-3510

SOLICITATION AMENDMENT
MODIFICATION DE L'INVITATION

The referenced document is hereby revised; unless otherwise indicated, all other terms and conditions of the Solicitation remain the same.

Ce document est par la présente révisé; sauf indication contraire, les modalités de l'invitation demeurent les mêmes.

Comments - Commentaires

Vendor/Firm Name and Address
Raison sociale et adresse du
fournisseur/de l'entrepreneur

Issuing Office - Bureau de distribution
Public Works and Government Services Canada
ATB Place North Tower
10025 Jasper Ave./10025 ave Jasper
5th floor/5e étage
Edmonton
Alberta
T5J 1S6

Title - Sujet Security & Demarcation Fence, Drum	
Solicitation No. - N° de l'invitation EW038-151785/A	Amendment No. - N° modif. 003
Client Reference No. - N° de référence du client PWGSC-EW038-151785	Date 2015-02-10
GETS Reference No. - N° de référence de SEAG PW-\$PWU-011-10355	
File No. - N° de dossier PWU-4-37226 (011)	CCC No./N° CCC - FMS No./N° VME
Solicitation Closes - L'invitation prend fin at - à 02:00 PM on - le 2015-02-17	Time Zone Fuseau horaire Mountain Standard Time MST
F.O.B. - F.A.B. Plant-Usine: <input type="checkbox"/> Destination: <input checked="" type="checkbox"/> Other-Autre: <input type="checkbox"/>	
Address Enquiries to: - Adresser toutes questions à: Hugo (RPC), Tammey	Buyer Id - Id de l'acheteur pwu011
Telephone No. - N° de téléphone (780) 497-3917 ()	FAX No. - N° de FAX (780) 497-3510
Destination - of Goods, Services, and Construction: Destination - des biens, services et construction:	

Instructions: See Herein

Instructions: Voir aux présentes

Delivery Required - Livraison exigée	Delivery Offered - Livraison proposée
Vendor/Firm Name and Address Raison sociale et adresse du fournisseur/de l'entrepreneur	
Telephone No. - N° de téléphone Facsimile No. - N° de télécopieur	
Name and title of person authorized to sign on behalf of Vendor/Firm (type or print) Nom et titre de la personne autorisée à signer au nom du fournisseur/ de l'entrepreneur (taper ou écrire en caractères d'imprimerie)	
Signature	Date

Solicitation No. - N° de l'invitation

EW038-151785/A

Client Ref. No. - N° de réf. du client

PWGSC-EW038-151785

Amd. No. - N° de la modif.

003

File No. - N° du dossier

PWU-4-37226

Buyer ID - Id de l'acheteur

pwu011

CCC No./N° CCC - FMS No/ N° VME

Security and Demarcation Fence Repair
Drumheller Institution
Drumheller, Alberta
Project No. R.049481.002

Addendum No.3

Date: February 09, 2015

The following changes to the Tender Documents are effective immediately.
This addendum will form part of the Construction Contract documents.

Invitation To Tender Specifications :

Delete in its entirety and replace with the attached Addendum 3 Revised Specification Feb9-2015.

ADD: Quality Assurance Review attached

ADD: Questions and Answers attached

End of Addendum

Section Number	Section Title	Pages
Division 00-01		
01 00 10	General Instructions	5
01 14 00	Work Restrictions	3
01 14 10	Security Restrictions	9
01 23 10	Alternatives	1
01 31 19	Project Meetings	3
01 33 10	Submittal Procedures	5
01 35 43	Environmental Procedures	2
01 41 00	Regulatory Requirements	1
01 45 00	Quality Control	3
01 47 19	Sustainable Requirements: Operation	6
01 51 00	Temporary Facilities	2
01 52 00	Construction Facilities	5
01 56 00	Temporary Barriers and Enclosures	2
01 61 00	Common Products Requirements	4
01 74 11	Cleaning	1
01 74 21	Construction Demolition	7
01 77 00	Closeout Procedures	2
01 78 00	Closeout Submittals	6
Division 03 - Concrete		
03 20 00	Concrete Reinforcing	2
03 30 00	Cast-in-Place Concrete	5
Division 05 - Metals		
05 50 00	Metal Fabrications	4
Division 09 - Finishes		
09 97 19	Painting Exterior Metal	6
Division 31 - Earthwork		
31 23 33.01	Excavating, Trenching & Backfilling	5
Division 32 - Exterior Improvements		
32 31 13	Chain Link Fences and Gates	6
Appendix A		
CSC Technical Criteria		

Section Number	Section Title	Pages
-----------------------	----------------------	--------------

Drawing List

D-C01	General Notes	
D-C02	Project Notes Sheet 1 Current Year	
D-C03	Project Notes Sheet 2 Current Year	
D-C04	Project Notes Sheet 3 Current Year Plus One	
D-C05	Overall Site Plan	
D-C06	Site Plan NE Quadrant	
D-C07	Site Plan SE Quadrant	
D-C08	Site Plan NW Quadrant	
D-C09	Site Plan SW Quadrant	
D-C10	Details Sheet 1	
D-C11	Details Sheet 2	
D-C12	Details Sheet 3	
D-C13	Details Sheet 4	
D-C14	Details Sheet 5	

1. GENERAL

1.1 DESCRIPTION OF WORK

- .1 Work under this contract includes repairs and replacements to portions of the security and demarcation perimeter fencing, including upgrades to the Sallyport Gates to the Drumheller Penitentiary, Alberta.
- .2 The site is located at the Drumheller Institution, Drumheller, Alberta.

1.2 FAMILIARIZATION WITH SITE

- .1 Before submitting their tender, it is required that bidders attend the scheduled Pre-Tender Site Meeting to inspect and examine the site and its surrounding and satisfy themselves as to:
 - .1 The form and nature of the work and materials necessary for the completion of the work.
 - .2 Means of access to the site.
 - .3 Accommodation they may require.
 - .4 Obtain information regarding risks, security costs and impediments, contingencies.
 - .5 Other site conditions or circumstances which may influence or affect their tender.
- .2 The Pre-Tender Site meeting will be held at the date and time stated in the Call for Tenders document.
- .3 No consideration will be given or subsequently permitted due to error, omission or negligence as a result of failure to identify issues that are evident on site at the time of the site meeting.
- .4 Prior to starting work on fences contact MDS and FDS specialist:
 - .1 Don Envoldsen
Email: denvoldsen@csc.adga.ca
Phone: 1-403-436-0227

1.3 CODES AND STANDARDS

- .1 Perform work in accordance with the 2010 National Building Code of Canada and any other code of Federal, provincial or local application including all amendments as specifically stated or required, up to project tender closing date. In case of any conflict or discrepancy, the more stringent requirements shall apply.
- .2 Materials and workmanship must meet or exceed the minimum requirements of the specified standards, codes and referenced documents, and the specifications and drawings (including the most recent CSC Technical Criteria).

1.4 SETTING OUT OF WORK

- .1 Assume full responsibility for and execute complete layout of work to locations, lines and elevations where indicated.
- .2 Provide devices and equipment necessary to lay-out and accurately construct the Work.
- .3 Supply devices such as straight edges and templates required to facilitate the inspection of the Work by the Departmental Representative or other Authority Having Jurisdiction.
- .4 Supply stakes and other survey markers required for laying out the Work.

1.5 INTERPRETATION OF DOCUMENTS

- .1 Supplementary to the General Conditions, Division 01 Sections of the Specifications take precedence over technical specifications in other Divisions of the Specifications.
- .2 Specifications shall take precedence over drawings.
- .3 Drawing details shall take precedence over large scale plans.

1.6 COST BREAKDOWN

- .1 Before submitting first progress claim, submit breakdown of Contract price in detail as directed by the Departmental Representative, categorizing by Section and Trade, and aggregating the contract price. Departmental Representative will provide the required forms for application of Progress Claim.
- .2 Monthly Progress Claim must include a cost breakdown, updated / current work schedule and progress photographs when specifically requested.

1.7 PROJECT MEETINGS

- .1 Chair Project Meetings at regularly established times and locations as determined by the Departmental Representative.
- .2 Notify all participants of meeting dates and times at least one week prior to the meeting.
- .3 Record minutes of meetings, distribute to all participants by fax or email within two working days of the meeting date. Make revisions to the Minutes as directed by the Departmental Representative, prior to the subsequent meeting.

1.8 DOCUMENTS REQUIRED ON SITE

- .1 Maintain at job site for the duration of the project, at least one copy each of the following:
 - .1 Contract Drawings (as Issued for Construction), and subsequent revisions.
 - .2 Specifications (as Issued for Construction), and subsequent revisions.
 - .3 Addenda to all IFC documents.

- .4 Reviewed Shop Drawings
- .5 List of outstanding shop drawings.
- .6 Change Orders.
- .7 Other modifications to Contract (Contemplated Change Notice / CCN, Change Directive / CD, Site Instruction / SI, Field Instruction / FI, etc.).
- .8 Field Test Reports.
- .9 Copy of approved Project Schedule.
- .10 Record drawings and documents to record 'as-built' changes.
- .11 Other documents as stipulated in the Contract Documents.
- .12 Site Specific Health and Safety Plan, and other safety related documents.

1.9 PERMITS

- .1 Obtain and pay for building permit, certificates, licenses and other permits as required by Municipal, Provincial and Federal authorities, in accordance with the General Conditions.
- .2 Provide written notifications of the project to municipal and provincial inspection authorities as required by the municipal or provincial authorities.
- .3 Obtain Compliance Certificates as prescribed by legislative and regulatory provisions of municipal, provincial and Federal authorities as applicable to the performance of work.
- .4 Submit to the Departmental Representative, a copy of application submissions and approval documents received for / from above referenced authorities.

1.10 EXISTING SERVICES

- .1 Before commencing work, establish location and extent of buried or concealed service lines in area of work and notify Departmental Representative of findings that may interfere or impede the work.
- .2 Where unknown or unexpected services are encountered at any time during the course of the Work, immediately advise the Departmental Representative, and confirm findings in writing. Record the information on the Record Drawings.
- .3 Do not remove, disturb, disconnect or de-energize the service without written permission or direction from the Departmental Representative.

1.11 ACCEPTANCE

- .1 Prior to the issuance of an Interim Certificate of Completion, perform a thorough review of all work in company with the Departmental Representative and compile a list of incomplete work and deficiencies. Correct all noted discrepancies before final inspection and acceptance.

- .2 Notwithstanding the General Conditions, the Contractor's attention is drawn to the fact that the Departmental Representative will not issue an Interim Certificate of Completion until such time that the Contractor turns over to the Departmental Representative all specified As-Built / Record Drawings and documents, training manuals, Operations and Maintenance (O&M) manuals, certificates of tests and test results.

1.12 WORKS COORDINATION

- .1 The General Contractor is responsible for coordinating the work of the various trades, where the work of such trades interfaces with others.
- .2 Ensure coordination and cooperation between trades in order to facilitate the general progress of the work.
- .3 Shop drawing review and material ordering shall only commence after this coordination has taken place between trades and all conditions affecting the work of the interfacing trades has been made known and accounted.
- .4 Public Works and Government Services Canada (PWGSC) will not be responsible or held accountable for any additional costs incurred as a result of the failure to coordinate the work of the trades. Resolution of disputes between trades regarding the areas or work and extent of interface work shall be the sole responsibility of the General Contractor at no additional cost to PWGSC.

1.13 OTHER CONTRACTS

- .1 Other Contracts may be let during the period that the course of the work of this contract is active.
- .2 The Contractor will remain as the Prime Contractor within the defined construction site, and will cooperate with other Contractors in carrying out respective works.
- .3 Coordinate work with that of other Contractors as required to complete the contract. If any part of the work under this Contract depends for its proper execution or result upon the work of another Contractor, report promptly to the Departmental Representative, in writing, any interference, defects or delays in the work of such other Contractors as may impede with the proper execution of this work.
- .4 The Contractor is to ensure that the completion date of this contract does not extend beyond the original Schedule, except when extension to the Schedule is permitted by the Department Representative as a result of a Change Order. The Contractor may be held responsible for any liquidated damages incurred by PWGSC as a result of a delay of the scheduled completion date.

1.14 SMOKING ENVIRONMENT

- .1 Comply with all smoking restrictions on site and adjacent to the site as regulated by the Institution.

1.15 CONTRACT DOCUMENTS

- .1 The Departmental Representative will provide five (5) sets of Contract Documents for use by the contractor at the award of the Contract.
- .2 Additional sets required by the Contractor will be provided at cost to the contractor.

END OF SECTION

1. GENERAL

1.1 WORK SCHEDULE

- .1 Submit within 7 calendar days of Notification of Acceptance of tender and contract award, a construction Work Schedule showing commencement and completion dates of all work defined within the time stated in the accepted tender.
- .2 Provide sufficient details in the Work Schedule to clearly illustrate entire implementation plan, depicting efficient coordination of tasks and resources to achieve completion of work on time and to permit the effective monitoring of work progress in relation to established milestones.
- .3 As a minimum, the Work Schedule is to be prepared and submitted in the form of Bar (GANTT) Chart indicating work activities, tasks and other project elements, their anticipated durations and planned dates for achieving key activities and major project milestones, provided in sufficient details and supported by narratives to demonstrate a reasonable plan for completion of project within designated time. Bar Charts derived from a commercially available computerized project management system are preferred, i.e. MS Projects.
- .4 Schedule the work in cooperation with the Departmental Representative. Departmental Representative's decision is final in regards to time and order of work. Incorporate within Work Schedule, items identified by the Departmental Representative during review of schedule.
 - .1 Work described as current year construction is to be completed by March 31, 2015.
 - .2 Work described as current year plus one construction is to be completed by August 31, 2015.
- .5 Completed Work Schedule shall be submitted for the approval of the Departmental Representative. When the Work Schedule has been approved, take necessary measures to complete all work within the scheduled time. Schedule is not to be changed without approval of the Departmental Representative, or as a result of work extension approved in a Change Order.
- .6 Work Schedule must take into consideration and reflect the work phasing, special conditions and operational restrictions set out below.
- .7 It is the Contractor's responsibility to ensure all sub-trades and subcontractors are made aware of the work constraints and operational restrictions specified.
- .8 Submit schedule updates on a monthly basis and more often when requested by the Departmental Representative, due to frequent changing project conditions. Provide a narrative explanation of problem areas, anticipated delays, impact on schedule and the proposed corrective action to be taken.
- .9 Interim reviews of work progress based on the approved schedule will be conducted as decided by Departmental Representative. Address and make corrective measures to the work and update the schedule as directed.

- .10 Work Scheduling, no matter how minimal the risk or impact on safety or inconvenience might appear, will be subject to prior review and approval by the Departmental Representative.

1.2 USE OF SITE AND FACILITIES

- .1 Execute the work with least possible interference or disturbance to normal use of premises. Make arrangements with Departmental Representative to facilitate the work as stated.
- .2 All security items/services taken down must be repaired and re-installed or replaced on the same day prior to the Contractor leaving the site.
- .3 Maintain existing services to the site and buildings and provide for personnel and vehicle access.
- .4 Where security is reduced by work activities, provide temporary means to maintain security, approved by the Departmental Representative.
- .5 Closures: protect work temporarily until permanent enclosures are completed.

1.3 OPERATIONAL

- .1 The Contractor must perform the work with regard to the safety of the workers, penitentiary staff and inmates. All work activities must be planned and scheduled with this in mind. The Contractor will not be permitted to disturb any portion of the site without providing temporary facilities as necessary to ensure safe, secure and direct passage through disturbed or otherwise affected areas.
- .2 Contractor to meet with the Departmental Representative on a weekly basis to identify intended work areas, activities and scheduling for the coming week.
- .3 Provide on-site, and erect as required during progress of work, approved bilingual signage, mounted on self-supporting stands, warning the public of construction activities in progress and alerting the need to exercise caution. Signage to be professionally printed and mounted on wooden backing, colored and to express messages as directed by the Departmental Representative. Size of sign should be approximately 1.0 square meter, and appropriate to the message.
- .4 Erect construction hoarding and dust barriers as required for safety, security and ease of required work.
- .5 Ensure that all sub-trades are made aware and abide by the contents of this Section.

1.4 EXISTING SERVICES

- .1 Notify Departmental Representative and utility companies of intended interruption of services and obtain required permission.
- .2 Where Work involves breaking into or connecting to existing services, provide the Departmental Representative seven calendar days' notice for necessary interruption of mechanical or electrical service, for the duration of the Contract.

- .3 Carry out interruptions after normal working hours of occupants, preferably on weekends, as approved by Departmental Representative. Keep duration of interruptions to a minimum.
- .4 Provide and maintain access for penitentiary personnel and vehicular traffic at all times.

1.5 SECURITY CLEARANCES

- .1 All construction personnel employed on this project will be subject to a security check. Obtain CSC CPIC clearance as instructed by the Departmental Representative for each individual who will be required to enter the sites / premises. CPIC clearances can take up to two (2) weeks to obtain.
- .2 Personnel will be checked daily at the start of each work shift and provided with a pass which must be worn at all times. Pass must be returned at the end of the work shift and personnel checked out.

1.6 SECURITY ESCORT

- .1 Personnel employed on this project must be escorted when executing work in all areas of the site.
- .2 Submit an escort request to Departmental Representative at least two days before service is needed. For requests submitted within time noted above, costs of security escort will be paid for by CSC Region and may not be approved depending on availability of Commissionaires.
- .3 Any escort request may be cancelled if notification of cancellation is given at least 24 hours before scheduled time of escort.

END OF SECTION

1. GENERAL

1.1 PURPOSE

- .1 To ensure that both the construction project and the institutional operations may proceed without undue disruption or hindrance and that the security of the Institution is maintained at all times.

1.2 DEFINITIONS

- .1 "Contraband" means:
- .1 An intoxicant, including alcoholic beverages, drugs and narcotics;
 - .2 A weapon or a component thereof, ammunition for a weapon, and anything that is designed to kill, injure or disable a person or that is altered so as to be capable of killing, injuring or disabling a person, when possessed without prior authorization;
 - .3 An explosive or a bomb or a component thereof;
 - .4 Currency over any applicable prescribed limit \$50.00; and
 - .5 Any item not described in sentences (1) to (4) above that could jeopardize the security of a Penitentiary or the safety of persons, when that item is possessed without prior authorization.
- .2 "Unauthorized Smoking and related Items" means all smoking items including, but not limited to cigarettes, cigars, tobacco, chewing tobacco, cigarette making machines, matches and lighters.
- .3 "Commercial Vehicle" means any motor vehicle used for the shipment of material, equipment and tools required for the construction project.
- .4 "CSC" means Correctional Service Canada.
- .5 "Director" means Director, Warden or Superintendent of the Institution as applicable.
- .6 "Construction employees" mean persons working for the general contractor, the sub-contractors, equipment operators, material suppliers, testing and inspection companies and regulatory agencies.
- .7 "Departmental Representative" means the project manager from Public Works and Government Services Canada.
- .8 "Perimeter" means the fenced or walled area of the institution that restrains the movement of the inmates.
- .9 "Construction limits" means the area as shown on the contract drawings that the contractor will be allowed to work. This area may or may not be isolated from the

security area of the institution. These are the immediate areas in and around the security and demarcation fencing areas.

1.3 PRELIMINARY PROCEEDINGS

- .1 Prior to the commencement of work, the contractor will meet with the Director or his representative to:
 - .1 Discuss the nature and extent of all activities involved in the Project.
 - .2 Establish mutually acceptable security procedures in accordance with this instruction and the institution's particular requirements.
- .2 The contractor will:
 - .1 Ensure that all construction employees are aware of the security requirements.
 - .2 Ensure that a copy of the security requirements is always prominently on display at the job site.
 - .3 Co-operate with institutional personnel in ensuring that security requirements are observed by all construction employees.

1.4 CONSTRUCTION EMPLOYEES

- .1 Submit to the Director a list of the names with date of birth of all construction employees to be employed on the construction site and a security clearance form for each employee.
- .2 Allow two (2) weeks for processing of security clearances. Employees will not be admitted to the Institution without a valid security clearance in place and recent photo identification such as a Provincial driver's license. Security clearances obtained from other CSC institutions are not valid at this institution.
- .3 The Director may require that facial photographs may be taken of construction employees and these photographs may be displayed at appropriate locations in the institution or in an electronic database for identification purposes. The Director may require that Photo ID cards be provided for all construction workers. ID cards will then be left at the designated entrance to be picked upon arrival at the institution and shall be displayed prominently on the construction employees clothing at all time while employees are in the institution. Verify this requirement with the Departmental Representative.
- .4 Entry to Institutional Property will be refused to any person when there may be reason to believe they may be a security risk.
- .5 Any person employed on the construction site will be subject to immediate removal from Institutional Property if they:
 - .1 Appear to be under the influence of alcohol, drugs or narcotics;
 - .2 Behave in an unusual or disorderly manner;
 - .3 Are in possession of contraband.

1.5 VEHICLES

- .1 All unattended vehicles on CSC property shall have windows closed; doors and trunks shall be locked and keys removed. The keys shall be securely in the possession of the owner or an employee of the company that owns the vehicle. The Institution requires lockable gas caps on all vehicles and motorized equipment used in the construction area.
- .2 The director may limit at any time the number and type of vehicles allowed within the Institution.
- .3 Drivers of delivery vehicles for material required by the project will not require security clearances but must remain with their vehicle the entire time that the vehicle is in the Institution. The director may require that these vehicles be escorted by Institutional staff or Commissionaires while in the Institution.
- .4 If the Director permits trailers to be left inside the secure perimeter of the Institution, these trailer doors will be locked at all times. All windows will be securely locked when left unoccupied. All trailer windows shall be covered with expanded metal mesh. All storage trailers inside and outside the perimeter must be locked when not in use.

1.6 PARKING

- .1 The parking area(s) to be used by construction employees will be designated by the Director. Parking in other locations will be prohibited and vehicles may be subject to removal.

1.7 SHIPMENTS

- .1 All shipments of project material, equipment and tools shall be addressed in the Contractor's name to avoid confusion with the institution's own shipments. The contractor must have his own employees on site to receive any deliveries or shipments. CSC staff will NOT accept receipt of deliveries or shipments of any material equipment or tools.

1.8 TELEPHONES

- .1 There will be no installation of telephones, facsimile machines and computers with Internet connections permitted within the perimeter of the institution unless prior approval of the Director is received.
- .2 The Director will ensure that approved telephones, facsimile machine and computers with Internet connections are located where they are not accessible to inmates. All computers will have an approved password protection that will stop an Internet connection to unauthorized personnel.
- .3 Wireless cellular and digital telephones, including but not limited to devices for telephone messaging, pagers, smartphones, telephone used as 2-way radios, are not permitted within the perimeter of the Institution unless approved by the Director. If wireless cellular telephones are permitted, the user will not permit their use by any inmate.
- .4 The Director may approve but limit the use of two way radios.

1.9 WORK HOURS

- .1 Work hours within the Institution are: Monday to Friday 8:00 a.m. (0800hrs) to 4:00 p.m. (1600 hrs).
- .2 Work will not be permitted during weekends and statutory holidays without the written permission of the Director. A minimum of seven days advance notice will be required to obtain the required permission. In case of emergencies or other special circumstances, this advance notice may be waived or period shortened by the Director.

1.10 OVERTIME WORK

- .1 No overtime work will be allowed without permission of the Director. Give a minimum forty-eight (48) hours advance notice when overtime work on the construction project is necessary and approved. If overtime work is required because of an emergency such the completion of a concrete pour or work to make the construction safe and secure, the contractor will advise the Director as soon as this condition is known and follow the directions given by the Director. Costs to the Crown for such events may be attributed to the contractor.
- .2 When overtime work, weekend statutory holiday work is required and approved by the Director, extra staff members may be posted by the Director or his designate, to maintain the security surveillance. The Departmental Representative may post extra staff for inspection of construction activities. The actual cost of this extra staff may be subject to reclamation by the Crown.

1.11 TOOLS AND EQUIPMENT

- .1 Maintain a complete list of all tools and equipment to be used during the construction project. Make this inventory available for inspection when required. Tool lists are to include the following as well as any screw & or drill bits and any disposable tool items such as disposable blades etc.
 - .1 Restricted tools (tools requiring special permission to carry on to site).
 - .1 Explosive tools (Hilti-gun, etc.)
 - .2 Bolt cutters
 - .3 Acids
 - .4 Bottle jacks (hydraulic)
 - .5 Knives (other than approved hobby knives and cutlery)
 - .6 Scissors, tailors;
 - .7 Adjustable wrenches, 10" long or more;
 - .8 Tin snips
 - .9 Linesmen pliers

- .10 Metal cutting devices
 - .11 Hacksaw blades, wrecking or cross bars
 - .12 Files
 - .13 Vice grip pliers with cutters in jaws
 - .14 Picks
 - .15 Portable, electrically driven power tools capable of cutting or drilling (skill saws, jigsaws and drill motors)
 - .16 Welding equipment (accessories locked up)
 - .17 Rope, heavy cord
 - .18 Axes
 - .19 Ladders
 - .20 Gasoline
 - .21 Coal oil, turpentine
 - .22 Lacquers and sealers
 - .23 Pure ammonia
 - .24 Pneumatic guns and staplers
 - .25 Propane cylinders
- .2 Non restricted tools include tools which are used daily and are not usually expected to be used to affect an escape.
- .2 Throughout the construction project maintain up-to-date the list of tools and equipment specified above.
- .3 Keep all tools and equipment under constant supervision, particularly power-driven and cartridge-driven tools, cartridges, files, saw blades, rod saws, wire, rope, ladders and any sort of jacking device.
- .4 Store all tools and equipment in approved secure locations.
- .5 Lock all tool boxes when not in use. Keys are to remain in the possession of the employees of the contractor. Scaffolding shall be secured and locked when not erected and when erected, will be secured in a manner agreed upon with the Institutional designate.
- .6 All missing or lost tools or equipment shall be reported immediately to the Director.

- .7 The Director will ensure that the security staff members carry out checks of the Contractor's tools and equipment against the list provided by the Contractor. These checks may be carried out at the following intervals:
 - .1 At the beginning and conclusion of every construction project.
 - .2 Weekly, when the construction project extends longer than a one week period.
 - .3 The Contractor may be subject to random checks by security staff to ensure proper storage and security of tools throughout the project.
- .8 Certain tools/equipment such as cartridges and hacksaw blades are highly controlled items. The contractor will be given at the beginning of the day, a quantity that will permit one day's work. Used blades/cartridges will be returned to the Director's representative at the end of each day.
- .9 If propane or natural gas is used for heating the construction, the institution will require that an employee of the contractor supervise the construction site during non-working hours.

1.12 KEYS

- .1 Security Hardware Keys
 - .1 The Contractor shall arrange with the security hardware supplier/installer to have the keys for the security hardware to be delivered directly to Institution, specifically the Security Maintenance Officer (SMO).
 - .2 The SMO will provide a receipt to the Contractor for security hardware keys.
 - .3 The contractor will provide a copy of the above-mentioned receipt to the Engineer.
- .2 Other Keys
 - .1 The contractor will use standard construction cylinders for locks for his use during the construction period.
 - .2 The contractor will issue instructions to his employees and sub-trades, as necessary, to ensure safe custody of the construction set of keys.
 - .3 Upon completion of each phase of the construction, the CSC representative will, in conjunction with the lock manufacturer:
 - .1 Prepare an operational keying schedule;
 - .2 Accept the operational keys and cylinders directly from the lock manufacturer;
 - .3 Arrange for removal and return of the construction cores and install the operational core in all locks.

- .4 Upon putting operational security keys into use, the CSC construction escort shall obtain these keys as they are required from the SMO and open doors as required by the Contractor. The Contractor shall issue instructions to his employees advising them that all security keys shall always remain with the CSC construction escort.

1.13 SECURITY HARDWARE

- .1 Turn over all removed security hardware to the Director of the Institution for disposal or for safekeeping until required for re-installation.

1.14 PRESCRIPTION DRUGS

- .1 Employees of the contractor who are required to take prescription drugs during the workday shall obtain approval of the Director to bring a one day supply only into the Institution.

1.15 SMOKING RESTRICTIONS

- .1 Contractors and construction employees are not permitted to smoke inside correctional facilities or outdoors within the perimeter of a correctional facility and must not possess unauthorized smoking items within the perimeter of a correctional facility.
- .2 Contractors and construction employees who are in violation of this policy will be requested to immediately cease smoking or dispose of any unauthorized smoking items and, if they persist, will be directed to leave the institution.
- .3 Smoking is only permitted outside the perimeter of a correctional facility in an area to be designated by the Director.

1.16 CONTRABAND

- .1 Weapons, ammunition, explosives, alcoholic beverages, drugs and narcotics are prohibited on institutional property.
- .2 The discovery of contraband on the construction site and the identification of the person(s) responsible for the contraband shall be reported immediately to the Director.
- .3 Contractors should be vigilant with both their staff and the staff of their sub-contractors and suppliers that the discovery of contraband may result in cancellation of the security clearance of the affected employee. Serious infractions may result in the removal of the company from the Institution for the duration of the construction.
- .4 Presence of arms and ammunition in vehicles of contractors, sub-contractors and suppliers or employees of these will result in the immediate cancellation of security clearances for the driver of the vehicle.

1.17 SEARCHES

- .1 All vehicles and persons entering institutional property may be subject to search.

- .2 When the Director suspects, on reasonable grounds, that an employee of the Contractor is in possession of contraband or unauthorized items, he may order that person to be searched.
- .3 All employees entering the Institution may be subject to screening of personal effects for traces of contraband drug residue.

1.18 ACCESS TO AND FROM INSTITUTIONAL PROPERTY

- .1 Construction personnel and commercial vehicles will not be admitted to the institution after normal working hours, unless approved by the Director.

1.19 MOVEMENT OF VEHICLES

- .1 Escorted commercial vehicles will be allowed to enter or leave the institution through the vehicle access gate during the following hours:
 - .1 08:00 a.m. to 0:400 p.m. (or within approved hours of work).
- .2 The contractor shall advise the Director twenty four (24) hours in advance to the arrival on the site of heavy equipment such as concrete trucks, cranes, etc.
- .3 Vehicles being loaded with soil or other debris, or any vehicle considered impossible to search must be under continuous supervision by CSC staff or Commissionaires working under the authority of the Director.
- .4 Commercial vehicles will only be allowed access to institutional property when their contents are certified by the Contractor or his representative as being strictly necessary to the execution of the construction project.
- .5 Vehicles shall be refused access to institutional property if, in the opinion of the Director, they contain any article which may jeopardize the security of the institution.
- .6 Private vehicles of construction employees will not be allowed within the security wall or fence of medium or maximum security institutions without the permission of the Director.
- .7 With prior approval of the Director, a vehicle may be used in the morning and evening to transport a group of employees to the work site. This vehicle will not remain within the Institution the remainder of the day.
- .8 With the approval of the Director, certain equipment may be permitted to remain on the construction site overnight or over the weekend. This equipment must be securely locked, with the battery removed and keys kept by the Commissionaires for the duration of the project. The Director may require that the equipment be secured with a chain and padlock to another solid object.

1.20 MOVEMENT OF CONSTRUCTION EMPLOYEES ON INSTITUTIONAL PROPERTY

- .1 Subject to the requirements of good security, the Director will permit the Contractor and his employees as much freedom of action and movement as is possible.
- .2 Notwithstanding paragraph above, the Director may:

- .1 Prohibit or restrict access to any part of the institution.
- .2 Require that in certain areas of the institution, either during the entire construction project or at certain intervals, construction employees only be allowed access when accompanied by a member of the CSC security staff.
- .3 During the lunch and coffee/health breaks, all employees will remain within the construction site. Employees are not permitted to eat in the officer's lounge and dining room.

1.21 SURVEILLANCE AND INSPECTION

- .1 Construction activities and all related movement of personnel and vehicles will be subject to surveillance and inspection by CSC security staff members to ensure that established security requirements are met.
- .2 CSC staff members will ensure that an understanding of the need to carry out surveillance and inspections, as specified above, is established among construction employees and maintained throughout the construction project.

1.22 STOPPAGE OF WORK

- .1 The director may request at any time that the contractor, his employees, sub-contractors and their employees not enter or leave the work site immediately due to a security situation occurring within the Institution. The contractor's site supervisor shall note the name of the staff member making the request and the time of the request and obey the order as quickly as possible.
- .2 The contractor shall advise the Departmental Representative within 24 hours of this delay to the progress of the work.

1.23 CONTACT WITH INMATES

- .1 Unless specifically authorized, it is forbidden to come into contact with inmates, to talk with them, to receive objects from them or to give them objects. Any employee doing any of the above will be removed from the site and his security clearance revoked.
- .2 It is forbidden to take pictures of inmates, of CSC staff members or of any part of the Institution other than those required as part of this contract.

1.24 COMPLETION OF CONSTRUCTION PROJECT

- .1 Upon completion of the construction project or, when applicable, the takeover of a facility, the Contractor shall remove all remaining construction material, tools and equipment that are not specified to remain in the Institution as part of the construction contract.

END OF SECTION

1. GENERAL

1.1 REQUIREMENTS

- .1 Referenced specification Sections stipulate pertinent requirements for products and methods to achieve the Work stipulated under each Alternative.
- .2 Coordinate affected related Work and modify surrounding Work to integrate the Work under each Alternative.

1.2 CONTRACT AWARD / SELECTION OF ALTERNATIVES

- .1 Bids will be evaluated on the 'Base Bid' price. After determination of the preferred and/or lowest Bidder.
- .2 The low Bid shall be determined on the basis of the lowest total bid price in accordance with Contract Documents on which the Project is tendered.

END OF SECTION

1. GENERAL

1.1 ADMINISTRATIVE

- .1 Schedule and administer regular Project Meetings throughout the progress of the work at the call of Departmental Representative.
- .2 Prepare agenda for meetings.
- .3 Distribute agenda and written notice of each meeting five calendar days prior to the meeting date to Departmental Representative.
- .4 Provide physical space and make arrangements for meetings.
- .5 Preside at meetings.
- .6 Record the meeting minutes. Include significant proceedings and decisions. Identify actions assigned and action dates required by parties.
- .7 Reproduce and distribute copies of Meeting Record within five working days after meetings and transmit to meeting participants, all affected parties not in attendance, and the Departmental Representative.
- .8 Representative of Contractor, Subcontractor and suppliers attending meetings will be qualified and authorized to act on behalf of party each represents.

1.2 PRECONSTRUCTION MEETING

- .1 Within 5 calendar days after award of Contract, request a meeting of parties in contract to determine, discuss and resolve administrative procedures and responsibilities.
- .2 Senior representatives of Departmental Representative, Consultant, Contractor, major Subcontractors, field inspectors and supervisors will be in attendance.
- .3 Incorporate mutually agreed variations to Contract Documents into Agreement, prior to signing.
- .4 Agenda is to include but is not limited to the following:
 - .1 Appointment of official representative of participants in the Work.
 - .2 Schedule of Work: in accordance with Project Schedule submitted with bid.
 - .3 Schedule of submission of shop drawings, samples, etc. Submit all submittals in accordance with Section 01 33 10 - Submittal Procedures.
 - .4 Requirements for temporary facilities, site sign, offices, storage shed, parking, utilities, and fences in accordance with Section 01 52 00 - Construction Facilities.
 - .5 Site security in accordance with Section 01 14 10 – Security Restrictions.

- .6 Health and Safety Plan.
- .7 Procedures and restrictions for fence painting, per Section 09 97 19.
- .8 Waste Management Plan and procedures.
- .9 Administrative procedures for changes, change orders, approvals required, mark-up percentages permitted, time extensions, overtime, administrative requirements.
- .10 Owner provided products.
- .11 Record drawings in accordance with Section 01 33 10 - Submittal Procedures.
- .12 Operations and Maintenance manuals in accordance with Section 01 78 00.
- .13 Take-over procedures, acceptance, warranties in accordance with Section 01 78 00 - Closeout Submittals.
- .14 Monthly progress claims, administrative procedures, photographs, hold back funds.
- .15 Appointment of inspection and testing agencies or firms.
- .16 Insurances, transcript of policies.
- .5 Record the meeting minutes. Include significant proceedings and decisions. Identify actions assigned and dates required by parties.
- .6 Reproduce and distribute copies of minutes within five working days after meetings and transmit to meeting participants, all affected parties not in attendance, and the Departmental Representative.

1.3 PROGRESS MEETINGS

- .1 During course of Work and until two weeks prior to project completion, schedule progress meetings monthly for the site.
- .2 Contractor, Consultant, Departmental Representative and major active Subcontractors involved in the Work and are to be in attendance.
- .3 Notify parties minimum five days prior to meetings.
- .4 Record minutes of meetings and circulate to attending parties and affected parties not in attendance within five days after meeting.
- .5 Agenda is to include but is not limited to the following:
 - .1 Review, approval of minutes of previous meeting.
 - .2 Review of Work Schedule since previous meeting.

- .3 Field observations, problems, conflicts since last meeting.
- .4 Problems or issues which are expected to impede construction schedule.
- .5 Review of off-site fabrication delivery schedules.
- .6 Corrective measures and procedures to regain projected schedule.
- .7 Revision to construction schedule.
- .8 Progress schedule, during succeeding work period.
- .9 Review submittal schedules: expedite as required.
- .10 Maintenance of quality standards.
- .11 Review proposed changes for effect on construction schedule and on completion date.
- .12 Safety and security issues.
- .13 Other business.

- .6 Record the meeting minutes. Include significant proceedings and decisions. Identify actions assigned and dates required by parties.

- .7 Reproduce and distribute copies of minutes within five working days after meetings and transmit to meeting participants, all affected parties not in attendance, and the Departmental Representative.

END OF SECTION

1. GENERAL

1.1 ADMINISTRATIVE

- .1 Submit to Departmental Representative submittals listed for review, including:
 - .1 Shop drawings.
 - .2 Product data.
 - .3 Samples.
 - .4 Schedule.
 - .5 Permits.
 - .6 Photographs.
 - .7 Certificates.
 - .8 Other data, as specified in other sections of the Specifications.
- .2 Submit promptly and in an orderly sequence to prevent delay in the Work. Failure to submit in time is not considered sufficient cause for extension of Contract Schedule and no claim for extension by reason of such default will be considered.
- .3 Do not proceed with any Work affected by submittal until submittal review is complete and approved.
- .4 Do not proceed with work until site measurements have taken place, and all applicable adjustments are completed and approved.
- .5 Provide shop drawings, product data, samples and mock-ups in SI Metric units.
- .6 Where items or information is not produced in SI Metric units, converted values are acceptable.
- .7 Review submittals prior to submission to the Departmental Representative. This review represents that necessary requirements have been determined and verified, and that each submittal has been checked and coordinated with the requirements of the Work and Contract Documents. Submittals not stamped, signed, dated and identified for the specific project will be rejected and returned without being examined.
- .8 Notify Departmental Representative in writing at time of submission, identifying deviations from the requirements of Contract Documents, stating reasons for deviations.
- .9 Verify that field measurements and affected adjacent Work are coordinated.
- .10 Contractor's responsibility for errors and omissions in submission is not relieved by review of submittals.

- .11 Contractor's responsibility for deviations in submission from requirements of Contract Documents is not relieved by review of submittals.
- .12 Submittal format: paper originals, or clear and fully legible photocopies of originals. Facsimiles are not acceptable. Emailed digital submittals as PDFs are preferred unless oversized paper is required. In cases where oversized paper is required, the Departmental representative requires both a digital and a hard copy.
- .13 Make changes or revision to submissions which the Departmental Representative may require, consistent with the Contract Documents and resubmit as directed. When resubmitting, notify the Departmental Representative in writing of any revisions other than those requested.
- .14 Keep one reviewed copy of each submission on site.

1.2 SHOP DRAWINGS AND PRODUCT DATA

- .1 The term "shop drawings" means drawings, diagrams, illustrations, schedules, performance charts, brochures, data sheets and other data which are provided by Contractor to illustrate details of a component or portion of the Work.
- .2 Submission of documents for review does not give approval to proceed with proposed changes. Approval to proceed must be received in writing from the Departmental Representative prior to any work being done.
- .3 Submit drawings stamped and signed by a professional engineer registered and licensed in Province of Alberta.
- .4 Indicate materials, methods of construction and attachment or anchorage, erection diagrams, connections, explanatory notes and other information necessary for completion of Work. Where materials or equipment attach or connect to other components or equipment, indicate that such items have been coordinated, regardless of Section under which adjacent items will be supplied and installed. Indicate cross references to design drawings and specifications.
- .5 Allow 15 calendar days for review of each submission.
- .6 Adjustments made on shop drawings are not intended to change Contract Price. If adjustments affect value of Work, state such in writing to the Departmental Representative prior to proceeding with Work.
- .7 Make changes in shop drawings as Department Representative may request, consistent with Contract Documents. When resubmitting, notify in writing of revisions other than those requested.
- .8 Accompany submissions with transmittal letter, in duplicate, containing:
 - .1 Date.
 - .2 Project title and number.
 - .3 Contractor's name and address.

- .4 Identification and quantity of each shop drawing, product data and sample.
- .5 Other pertinent data.
- .9 Submitted documents include:
 - .1 Original date and revision dates.
 - .2 Project title and project number.
 - .3 Name and address of:
 - .1 Subcontractor.
 - .2 Supplier.
 - .3 Manufacturer.
 - .4 Contractor's stamp, signed by Contractor's authorized representative certifying approval of submissions, verification of field measurements and compliance with Contract Documents.
 - .5 Details of appropriate portions of Work as applicable, including:
 - .1 Fabrication.
 - .2 Layout, showing dimensions, including identified field dimensions, and clearances.
 - .3 Setting or erection details.
 - .4 Capacities.
 - .5 Performance characteristics.
 - .6 Standards.
 - .7 Operating weight.
 - .8 Wiring diagrams.
 - .9 Single line and schematic diagrams.
 - .10 Relationship to adjacent work.
- .10 After review, distribute copies as necessary to the supplier, manufacturer, sub-contractor, etc.
- .11 If upon review, no errors or omissions are discovered or if only minor corrections are made, copies will be returned and fabrication and installation of Work may proceed upon receipt of shop drawings. If shop drawings are rejected, noted copy will be returned and

resubmission of corrected shop drawings, through same procedure indicated above, must be provided prior to fabrication and installation of Work.

- .12 The review of shop drawings by Public Works and Government Services Canada (PWGSC) is for the sole purpose of ascertaining conformance with the specifications and installation.
 - .1 The review does not mean that PWGSC approves the detail design inherent in shop drawings, responsibility for which shall remain with Contractor submitting same, and such review shall not relieve the Contractor of responsibility for errors or omissions in shop drawings or of responsibility for meeting requirements of construction and Contract Documents.
 - .2 Without restricting the foregoing, Contractor is responsible for dimensions to be confirmed and correlated at job site, for information that pertains solely to fabrication processes or to techniques of construction and installation and for co-ordination of Work of sub-trades.

1.3 SAMPLES

- .1 Submit for review samples as specifically requested in respective Specification Sections. Label samples with origin and intended use.
- .2 Deliver samples prepaid to PWGSC Departmental Representative or to other address as directed. Deliver samples to the construction site unless previously or otherwise directed by the Departmental Representative.
- .3 Notify the Departmental Representative in writing at time of submission, of deviations in samples from requirements of Contract Documents.
- .4 Adjustments made on samples are not intended to change the Contract Price. If adjustments affect the value of Work, state such in writing prior to proceeding with Work.
- .5 Make changes in samples consistent with Contract Documents.
- .6 Reviewed and accepted samples will become the expected standard of workmanship and material against which installed Work will be verified.

1.4 SCHEDULES, PERMITS AND CERTIFICATES

- .1 Upon award of contract, submit to Departmental Representative copy of Work Schedule and various other schedules, permits, certification documents, Health and Safety Plan and project management plans as specified in other sections of the Specifications.
- .2 Submit copy of permits, notices, compliance Certificates received by Regulatory Agencies having jurisdiction and as applicable to the Work.
- .3 Submission of above documents to be in accordance with this Section.
- .4 Immediately after award of Contract, submit Workers' Compensation Board status.
- .5 Submit transcription of insurance immediately after award of Contract.

1.5 PHOTOGRAPHIC DOCUMENTATION

- .1 Each week, submit electronic copy of colour digital photography in JPG format, fine resolution, with progress statement as directed by Departmental Representative.
- .2 Project identification: name and number of project and date of exposure indicated.
- .3 Number of viewpoints: 2 locations. Viewpoints and their location as determined or directed by the Departmental Representative.
- .4 Photographs to be provided at the completion of excavation, foundation placement, framing, underground and concealed services, and as otherwise directed by the Departmental Representative.

END OF SECTION

1. GENERAL

1.1 REFERENCES

.1 Definitions:

- .1 Hazardous Material:** Product, substance, or organism that is used for its original purpose; and that is either dangerous goods or a material that may cause adverse impact to the environment or adversely affect health of persons, animals, or plant life when released into the environment.
- .2 Environmental Pollution and Damage:** presence of chemical, physical, biological elements or agents which adversely affect human health and welfare; unfavorably alter ecological balances of importance to human life; affect other species of importance to humankind; or degrade environment aesthetically, culturally and/or historically.
- .3 Environmental Protection:** prevention/control of pollution and habitat or environment disruption during construction. Control of environmental pollution and damage requires consideration of land, water, and air; biological and cultural resources; and includes management of visual aesthetics; noise; solid, chemical, gaseous, and liquid waste; radiant energy and radioactive material as well as other pollutants.

1.2 FIRES

- .1 Fires and burning of rubbish on site or adjacent to the site is not permitted.**

1.3 DRAINAGE

- .1 Provide temporary drainage and pumping required to keep excavations and site free from water.**
- .2 Ensure pumped water into waterways, sewer or drainage systems is free of suspended materials and contaminants or harmful substances.**
- .3 Control disposal or runoff of water containing suspended materials or other harmful substances in accordance with local authority requirements.**

1.4 DISPOSAL OF WASTES AND HAZARDOUS MATERIALS

- .1 Do not bury rubbish and waste materials on site.**
- .2 Do not dispose of hazardous waste including volatile materials, such as mineral spirits, paint thinner, oil or fuel into waterways, storm or sanitary sewers or municipal solid waste landfills.**
- .3 Store, handle and dispose of hazardous materials and hazardous waste in accordance with applicable federal and provincial laws, regulations, codes and guidelines.**

- .4 Maintain inventory of hazardous and toxic materials being kept on site, including leftover products and containers resulting from work. List product name, quantity and date when storage began. Maintain WHMIS – MSDS sheets on site.
- .5 Report spills or accidents immediately to the Departmental Representative and other authorities having jurisdiction. Submit a written spill report to the Departmental Representative within 24 hours of incident.
- .6 Have appropriate emergency spill response equipment available near hazardous material storage area including personal protective equipment.

1.5 WORK ADJACENT TO WATERWAYS

- .1 Construction equipment to be operated on land only.
- .2 Do not use waterway beds for borrow material without prior approval from Provincial Department of Environment and Federal Department of Fisheries & Oceans.
- .3 Waterways to be free of excavated fill, waste material and debris.
- .4 In borrow sites, design and construct temporary crossings to minimize erosion to waterways in strict conformance with Provincial and Federal environment protection regulations.

1.6 POLLUTION CONTROL

- .1 Maintain temporary erosion and pollution control features installed under this Contract.
- .2 Control emissions from equipment and plant to local authorities' emission requirements.
- .3 Prevent sandblasting and other extraneous materials from contaminating air and waterways beyond the application area.
 - .1 Provide temporary enclosures where directed by the Departmental Representative.
- .4 Cover or wet down dry materials and rubbish to prevent blowing dust and debris. Provide dust control for temporary roads.

END OF SECTION

1. GENERAL

1.1 REFERENCES AND CODES

- .1 Perform Work in accordance with National Building Code of Canada (NBC) including amendments up to tender closing date and other codes of provincial or local application provided that in case of conflict or discrepancy, more stringent requirements apply.
- .2 Meet or exceed requirements of:
 - .1 Contract documents.
 - .2 Specified standards, codes and referenced documents.

1.2 HAZARDOUS MATERIAL DISCOVERY

- .1 Asbestos: demolition of spray or trowel-applied asbestos is hazardous to health. Stop work immediately when material resembling spray or trowel-applied asbestos is encountered during demolition work. Notify Departmental Representative.
- .2 PCB: Polychlorinated Biphenyl: stop work immediately when material resembling Polychlorinated Biphenyl is encountered during demolition work. Notify Departmental Representative.
- .3 Mould: stop work immediately when material resembling mould is encountered during demolition work. Notify Departmental Representative.

1.3 BUILDING SMOKING ENVIRONMENT

- .1 Comply with smoking restrictions and municipal by-laws.

1.4 NATIONAL PARKS ACT

- .1 Perform Work in accordance with National Parks Act when projects are located within boundaries of National Park.

2. PRODUCTS

2.1 NOT USED

- .1 Not Used

3. EXECUTION

3.1 NOT USED

- .1 Not Used.

END OF SECTION

1. GENERAL

1.1 INSPECTION

- .1 Allow Departmental Representative access to Work. If part of Work is in preparation at locations other than Place of Work, allow access to such Work whenever it is in progress.
- .2 Give timely notice requesting inspection if Work is designated for special tests, inspections or approvals by Departmental Representative, or by inspection authorities having jurisdiction.
- .3 If Contractor covers or permits to be covered Work that has been designated for special tests, inspections or approvals before such is made, the Contractor shall uncover such Work to have inspections or tests satisfactorily completed, and make good such Work. Pay cost to uncover and make good such work.
- .4 Departmental Representative may order any part of Work to be examined if Work is suspected to be not in accordance with Contract Documents. If upon examination such work is found not in conformance with the Contract Documents, the Contractor shall correct such Work and pay cost of examination and correction.

1.2 INDEPENDENT INSPECTION AGENCIES

- .1 Independent Inspection/Testing Agencies may be engaged by the Departmental Representative for purpose of inspecting and/or testing portions of Work except for the following which remain part of Contractor's responsibilities:
 - .1 Inspection and testing required by laws, ordinances, rules, regulations or orders of public authorities.
 - .2 Inspection and testing performed exclusively for contractor's convenience.
 - .3 Testing, adjustment and balancing of conveying systems, mechanical and electrical equipment and systems, gate operators and controls, etc.
 - .4 Concrete tests.
 - .5 Mill tests and certificates of compliance.
 - .6 Tests as specified within various sections designated to be carried out by Contractor under the supervision of Departmental Representative.
- .2 Where tests or inspections by designated a Testing Agency reveal work not in accordance with contract requirements, Contractor shall pay costs for additional tests or inspections as Departmental Representative may require to verify acceptability of corrected work.
- .3 Employment of inspection and testing agencies by Departmental Representative does not discharge responsibility to perform Work in accordance with Contract Documents.

1.3 ACCESS TO WORK

- .1 Allow inspection/testing agencies access to Work, off site manufacturing and fabrication plants.
- .2 Co-operate to provide reasonable facilities for such access.
- .3 Make good work disturbed by inspections and tests.

1.4 PROCEDURES

- .1 Notify Departmental Representative in advance of requirement for tests, in order for Departmental Representative to make attendance arrangement with Testing Agency if necessary. When directed by Departmental Representative, notify such Agency directly.
- .2 When testing procedures are to be performed on site, advise the Departmental Representative of the test procedure, location, expected arrival date and time, and duration on site.
- .3 Submit representative samples of materials required for testing, as specifically requested in specifications. Submit with reasonable promptness and in orderly sequence to prevent delays in Work.
- .4 Provide labour and facilities to obtain and handle samples and materials on site. Provide sufficient space to store and cure test samples.

1.5 REJECTED WORK

- .1 Remove defective Work, whether result of poor workmanship, use of defective products or damage and whether incorporated in Work or not, which has been rejected by Departmental Representative as failing to conform to Contract Documents. Replace or re-execute in accordance with Contract Documents.
- .2 Make good other Contractor's work damaged by such removals or replacements promptly.

1.6 REPORTS

- .1 Submit 2 copies of inspection and test reports to Departmental Representative.
- .2 Provide copies to subcontractor of work being inspected or tested and/or manufacturer or fabricator of material being inspected or tested.

1.7 TESTS AND MIX DESIGNS

- .1 Furnish test results and mix designs as requested.

1.8 TESTING BY CONTRACTOR

- .1 Provide all necessary instruments, equipment and qualified personnel to perform tests designated as Contractor's responsibilities herein or elsewhere in the Contract Document.

- .2 At completion of tests, turn over 2 copies of fully documented test reports to Departmental Representative. Additionally, obtain other copies in sufficient quantities to enable one complete set of test reports to be placed in each of the maintenance manuals specified in Section 01 78 00 – Closeout submittals.

1.9 MILL TESTS

- .1 Submit mill test certificates as required of specification Sections.

1.10 EQUIPMENT AND SYSTEMS

- .1 Submit adjustment and reports for mechanical and electrical components of the gate operators as specified in trade sections.

END OF SECTION

1. GENERAL

1.1 PRECEDENCE

- .1 For Federal Government Projects, Division 1 Sections take precedence over technical specifications in other Divisions of this Project Manual.

1.2 DEFINITIONS

- .1 Electrical Facility means any system, equipment, device, apparatus, wiring, conductor, assembly or part thereof that is used for the generation, transformation, transmission, distribution, storage, control, measurement or utilization of electrical energy, and that has an amperage and voltage that is dangerous to persons.
- .2 Guarantee of Isolation: means a guarantee by a competent person in control or in charge that a particular facility or equipment is isolated.
- .3 De-energize: in the electrical sense, that a piece of equipment is isolated and grounded, e.g. if the equipment is not grounded, it cannot be considered de-energized (DEAD).
- .4 Guarded: means that equipment or facility is covered, shielded, fenced, enclosed, inaccessible by location, or otherwise protected in a manner that, to the extent that is reasonably practicable, will prevent or reduce danger to any person who might touch or go near such item.
- .5 Isolate: means that an electrical facility, mechanical equipment or machinery is separated or disconnected from every source of electrical, mechanical, hydraulic, pneumatic or other kind of energy that is capable of making it dangerous.
- .6 Live/alive: means that an electrical facility produces, contains, stores or is electrically connected to a source of alternating or direct current of an amperage and voltage that is dangerous or contains any hydraulic, pneumatic or other kind of energy that is capable of making the facility dangerous to persons.

1.3 ACTION AND INFORMATIONAL SUBMITTALS

- .1 Provide submittals for work Section in accordance with Section 01 33 10 - Submittal Procedures.
- .2 Submittals required:
 - .1 Submit copy of proposed Lockout Procedures and sample form of lockout permit or lockout tags for review.
 - .2 Submit documentation at Pre-Construction Meeting. Do not proceed with work until submittal has been reviewed and approved in writing by the Departmental Representative.

- .3 The contractor is to send the Departmental Representative a weekly update of areas that may require an Electrical Lock Out during the present and following week. This information will be passed on to the Client. The contractor is to then send an update to the Departmental Representative for that scheduled Lock Out no less than 48 hours prior to the requirement so the Client can make arrangements for this work to continue.

1.4 REFERENCES

- .1 CSA C22.1HB-02 - Canadian Electrical Code, Part 1, Safety Standard for Electrical Installations.
- .2 CSA C22.3 No. 1-01 - Overhead Systems.
- .3 CSA C22.3 No. 7-94 (R2000) – Underground Systems.
- .4 COSH, Canada Occupational Health and Safety Regulations made under Part II of the Canada Labour Code.
- .5 Alberta Occupational Health and Safety Code.

1.5 COMPLIANCE

- .1 Perform lockouts in compliance with:
 - .1 Canadian Electrical Code.
 - .2 Federal and Provincial Occupational Health and Safety Acts and Regulations.
 - .3 Regulations and code of practice as applicable to mechanical equipment or other machinery being de-energized.
 - .4 Procedures specified herein.
- .2 In event of conflict between any provisions of above authorities, the most stringent provision will apply. Should a dispute arise in determining the most stringent requirement, Departmental Representative will advise on the course of action to be followed.
- .3 All work on security electronics shall be performed by approved contractors by the manufacturers of the equipment. Manufacturers as follows:
 - .1 Senstar
Tom Coxford or other approved Senstar staff
119 John Cavanaugh Drive
Carp, Ontario K0A 1L0
T: 613.839.5572, Ext. 4310
F: 613.839.5830

- .2 Marcomm Systems Group
David Trudel, President, or other approved Marcomm staff
29 Antares Drive
Ottawa, Ontario K2E 7V2
T. 613.226.8866, Ext. 222
F: 613.226.8171

1.6 ISOLATION OF EXISTING SERVICES

- .1 This Section refers to all electrical systems and components affixed to the fencing, where such systems or components are to be temporarily de-energized and/or removed to accommodate fence repairs. This includes but is not limited to:
 - Perimeter Intrusion Detection System (PIDS)
 - CCTV cables
 - MDS cables between the perimeter fences
 - Fence grounding cables
 - Public address components (speakers, cables, junction boxes)
 - Lighting (fixtures, conduit or junction boxes, etc.)
- .2 Obtain written authorization from the Departmental Representative prior to conducting work on an existing active, energized service required as part of the work and before proceeding with lockout of such services.
- .3 To obtain authorization, submit to Departmental Representative the following documentation for each instance of lock-out of existing security systems and services, including:
 - .1 Written Request for Isolation of the service or facility;
 - .2 Copy of Contractor's Lockout Procedures;
 - .3 Details of temporary security requirements while fence and security systems are disabled.
 - .4 Detailed schedule of temporary fence and security system removal.
- .4 Make a Request for Isolation for each event, unless directed otherwise by Departmental Representative, and as follows:
 - .1 Fill-out standard forms in current use at the Facility when so directed by Departmental Representative or;
 - .2 Where no form exists at the Facility, make request in writing identifying:
 - .1 Type of system or equipment to be isolated, including its location;

- .2 Time duration, indicating start date/time, and completion date/time when isolation will be in effect.
- .3 Voltage of service feed to system or equipment being isolated.
- .4 Name of company and person making the request.
- .3 Document to be in typewritten format.
- .5 Do not proceed until receipt of written notification is received from Departmental Representative granting the Isolation Request and authorization to proceed with the isolation of designated equipment or facility. Departmental Representative may designate another individual at the Facility as the person authorized to grant the Isolation Request.
- .6 Conduct safe, orderly shut-down of equipment or facilities de-energize and isolate power and other sources of energy and lockout items in accordance with requirement of 'Lockouts' clause below.
- .7 Plan and schedule shut down of existing services in consultation with the Departmental Representative and the Facility Manager. Minimize impact and downtime of facility operations.
- .8 Determine in advance, as much as possible, in cooperation with the Departmental Representative, the type and frequency of situations which will require a Request for Isolation. Follow Departmental Representative's directives in this regard.
- .9 Conduct Hazard Assessments as part of the planning process of isolating existing equipment and facilities.
- .10 Be aware that a MDS cable is buried approximately 200 – 250mm below grade, between the perimeter fences. The contractor is not permitted to drive trucks or heavy equipment between the fences, but will be permitted to cross the cable when the grade is protected with plywood panels or similar protection. The contractor is liable for repairs to all / any damage to the MDS cable, as a result of this work
- .11 All work on security electronics shall be performed only by approved contractors by the manufacturers of the equipment. For a list of approved contractors, contact:
 - .1 Marcomm Systems Group

Mr. David Trudel, President, or other approved Marcomm staff
29 Antares Drive
Ottawa, Ontario K2E 7V2
Tel: 613.226.8866, Ext. 222
Fax.613.226.8171

- .2 Senstar (for PIDS and CCTV)

Tom Coxford or other approved Senstar staff
119 John Cavanaugh Drive
Carp, Ontario K0A 1L0
Tel: 613.839.5572, Ext. 4310
Fax: 613.839.5830

1.7 LOCKOUTS

- .1 Lockout electrical facilities, mechanical equipment and machinery from all potential energy sources prior to starting work on such items.
- .2 Develop and implement lockout procedures to be followed on site as an integral part of the Work.
- .3 Use energy isolation lockout devices specifically designed and appropriate for type of facility or equipment being locked out.
- .4 Use industry standard lockout tags.
- .5 Provide appropriate safety grounding and guards as required.
- .6 Prepare Lockout Procedures in writing. Describe safe work practices, work functions and sequence of activities to be followed on site to safely isolate all potential energy sources and lockout/tag out facilities and equipment.
- .7 Include within procedures a system of worker request and issuance of individual lockout permit by a person, employed by Contractor, designated to be "in-charge" and being responsible for:
 - .1 Controlling issuance of permits or tags to workers.
 - .2 Determining permit duration.
 - .3 Maintaining record of permits and tags issued.
 - .4 Submitting a Request for Isolation to the Departmental Representative when required in accordance with Clause 1.6 above.
 - .5 Designating a Safety Watcher, when one is required based on type of work.
 - .6 Ensuring equipment or facility has been properly isolated, providing a Guarantee of Isolation to worker(s) prior to proceeding with work.
 - .7 Collecting and safekeeping lockout tags, returned by workers, as a record of the event.
- .8 Clearly establish, describe and allocate, within procedures, the responsibilities of:
 - .1 Workers.
 - .2 Designated person controlling issuance of lockout tags/permits.

- .3 Safety Watcher.
- .4 Subcontractors and General Contractor
- .9 Procedures shall meet the requirements of Codes and Regulations specified in Clause 1.4 above.
- .10 Generic procedures, if used, must be edited, supplemented with pertinent information and tailored to reflect specific project conditions. Clearly label as being the procedures applicable to this contract:
 - .1 Incorporate site specific rules and procedures established by Facility Manager and in force at site. Obtain such procedures through Departmental Representative
- .11 Procedures to be in typewritten format.
- .12 Submit copy of Lockout Procedures to Departmental Representative, in accordance with submittal requirements noted above, prior to commencement of work.

1.8 CONFORMANCE

- .1 Ensure that lockout procedures, as established for project on site, are stringently followed. Enforce use and compliance by all workers.
- .2 Brief all persons working on electrical facilities, mechanical and other equipment fed by an energy source on the requirements of this section.

1.9 DOCUMENTS

- .1 Post Lockout Procedures on site in common on-site location for viewing by all workers.
- .2 Keep copies of Request for Isolation submitted to Departmental Representative and lockout permits or tags issued to workers during the course of work for full project duration.
- .3 Upon request, make such data available to Departmental Representative or to authorized safety representative for inspection.

END OF SECTION

1. GENERAL

1.1 ACCESS

- .1 The Contractor will be permitted access to the project site during working hours for the duration of the construction activities.
- .2 Maintain roads and new parking areas located within the construction compound and outside the institution. Provide dust control during period of work as required. CSC will provide snow clearing of the roads in winter months to ensure Contractor access to the site.
- .3 Make good all damage resulting from Contractors' use of existing roads.
- .4 Wash clean the access roads and parking areas used by Contractor's equipment as needed during the work, and upon completion of the project.

1.2 CONTRACTOR'S SITE OFFICE

- .1 Contractor will be responsible to provide their construction site office, including electricity, heat, lights and telephone. The site office location will be determined at the Construction Start-Up Meeting as directed by the Departmental Representative.

1.3 INSTALLATION AND REMOVAL

- .1 Provide temporary utilities controls in order to execute work expeditiously.
- .2 Remove from site all such work upon completion of the project.

1.4 SANITARY

- .1 Provide washroom and sanitary facilities for contractors own work force in accordance with governing regulations and ordinances, i.e. Occupational Health and Safety Code.
- .2 Post notices and take such precautions as required by local health authorities.
- .3 Keep area and premises in sanitary condition.
- .4 Contractors are not permitted use of the existing washroom facilities on site.

1.5 POWER

- .1 Arrange, pay for and maintain temporary electrical power supply in accordance with governing regulations and ordinances.
- .2 Supply and install all temporary facilities for power such as pole lines and underground cables to approval of local power supply authority.

1.6 WATER SUPPLY

- .1 Water supply for the Contractor's Site Office is the responsibility of the Contractor. Water for construction usage can be arranged through the Departmental Representative but the provision of piping, connection or other facilities as required to bring water to the site work will be the responsibility of the Contractor.

1.7 SITE NOTICES

- .1 Contractor or subcontractor advertisement freestanding signboards are not permitted on site. Use of signage on the site office to be approved by the Departmental Representative.
- .2 Safety and Instruction Signs and Notices:
- .3 Signs and notices for safety and instruction shall be in both official languages. Graphic symbols shall conform to CAN/CSA-Z321-96, Signs and Symbols for the Workplace.
- .4 Maintenance and Disposal of Site Signs:
 - .1 Maintain approved signs and notices in good condition for duration of project and dispose of offsite on completion of project or when otherwise directed by the Departmental Representative.

1.8 REMOVAL OF TEMPORARY FACILITIES

- .1 Remove temporary facilities from site upon completion of the project, or when otherwise directed by the Departmental Representative.

1.9 SITE SECURITY

- .1 Refer to Section 01 14 10 for all security restrictions.

END OF SECTION

1. GENERAL

1.1 ACTION AND INFORMATIONAL SUBMITTALS

- .1 Provide submittals in accordance with Section 01 33 10 - Submittal Procedures.

1.2 INSTALLATION AND REMOVAL

- .1 Prepare site plan indicating proposed location and dimensions of area to be fenced and used by Contractor, number and location of trailer(s) to be used, avenues of ingress/egress to fenced area and details of temporary construction fence installation.
- .2 Identify areas which must be graded and graveled to provide access and to prevent tracking of mud.
- .3 Indicate use of supplemental or other staging area.
- .4 Provide construction facilities in order to execute work expeditiously.
- .5 Remove from site all such work after use and project completion. Repair damaged roads and office/staging areas to original condition, or as otherwise directed by the Departmental Representative.

1.3 SCAFFOLDING

- .1 Scaffolding to be designed and constructed in accordance with CAN/CSA-S269.2.
- .2 Provide and maintain scaffolding, ladders and platforms as required for the duration of the work.

1.4 HOISTING

- .1 Provide, operate and maintain hoists and cranes required for moving of workers, materials and equipment.
- .2 Hoists and cranes to be operated only by trained, qualified and experienced operator.

1.5 SITE STORAGE/LOADING

- .1 Confine work and operations of employees by Contract Documents. Do not encumber premises with products or construction materials.
- .2 Do not load or permit to load any part of Work with weight or force that will endanger Work.
- .3 Load, unload and store construction equipment and materials only in locations approved and directed by the Departmental Representative.
- .4 Storage location is to be determined at Construction Start-up meeting. Contractor to provide enclosed locked storage or locked storage area contained by secure construction fencing.

1.6 CONSTRUCTION PARKING

- .1 Parking will not be permitted within the institution site, but only in area designated by the Departmental Representative.
- .2 Provide and maintain adequate secure access to project site for the duration of the project.
- .3 Do not restrict or impede access of adjacent roadways by Institution vehicles or security staff.

1.7 SECURITY

- .1 Construction items left onsite overnight or through the weekend/holidays must be in the construction laydown area approved by the Departmental Representative and must be locked by the Contractor with the key kept by the Commissionaires for the duration of the project.

1.8 OFFICES

- .1 Provide heated office space for the Prime Contractor, lighted and ventilated, of sufficient size to accommodate required site meetings, and furnished as noted herein.
- .2 Location of site office trailer to be situated where and as directed by the Departmental Representative, and shall be removed upon completion of the project or when otherwise directed by the Departmental Representative.
- .3 Provide marked and fully stocked first-aid case in a readily accessible location, conforming to OH&S Code, Part 11 First Aid.
- .4 Provide site office trailer for the contractor as follows:
 - .1 Maximum trailer size to be 15.85 m long x 3.6 m wide x 2.8 m high pre-manufactured site trailer, complete with opening windows and one or two lockable doors. Windows to be securely covered in steel bars or wire mesh.
 - .2 Electrical system to provide lighting, power and heat.
 - .3 Propane fired furnace and propane tanks.
 - .4 Provide private portable toilet facilities adjacent to office complete with supply of paper towels and toilet tissue.
 - .5 Provide potable water supply in site office.
 - .6 Equip office trailer with adequate furniture for a meeting room, private office(s), lunch area, etc., including one meeting table and chairs, shelving units, filing cabinet(s), one plan rack, one drawing layout table, and one coat rack and shelf.
 - .7 Maintain in clean condition for the duration of the project construction.
- .5 Subcontractor trailers are not permitted at the site.

1.9 EQUIPMENT, TOOL AND MATERIALS STORAGE

- .1 Provide and maintain, in clean and orderly condition, lockable weatherproof shed (or metal 'seacan' container) for storage of tools, equipment and construction materials.
- .2 Locate materials not required to be stored in weatherproof sheds on site in manner to cause least interference with work activities.
- .3 Location of storage units to be located where directed by the Departmental Representative. Shed shall be removed upon completion of the project or when otherwise directed by the Departmental Representative.

1.10 SANITARY FACILITIES

- .1 Provide sanitary facilities for work force in accordance with Provincial OH&S Code and other governing regulations and ordinances.
- .2 Post notices and take precautions as required by local health authorities. Keep area and premises in sanitary condition.
- .3 Contractor, subcontractor and workers will not be permitted to use Institution facilities.

1.11 CONSTRUCTION SIGNAGE

- .1 Prime Contractor is permitted to provide and erect a project sign, in a location designated and approved by the Departmental Representative.
- .2 Construction sign maximum 3 square meter size (4'x8') of plywood construction painted with exhibit lettering produced by a professional sign painter.
- .3 Indicate on sign the name of the Owner, the Consultant and Prime Contractor, of design/style approved by the Departmental Representative.
- .4 No other signs or advertisements, other than the site office sign and warning signs, are permitted on site.
- .5 Signs and notices for safety and instruction in both official languages. Graphic symbols to CAN/CSA-Z321.
- .6 Maintain approved signs and notices in good condition for duration of project, and dispose offsite on completion of project or earlier if directed by Departmental Representative.

1.12 PROTECTION AND MAINTENANCE OF TRAFFIC

- .1 Maintain and protect traffic on affected roads during construction period except as otherwise specifically directed by Departmental Representative.
- .2 Provide measures for protection and diversion of traffic, including provision of watch-persons and flag-persons, erection of barricades, placing of lights around and in front of equipment and work, and erection and maintenance of adequate warning, danger, and direction signs.

- .3 Protect Owner and public from damage to person and property.
- .4 Contractor's traffic on roads selected for hauling material to and from site shall not interfere with Institution or public traffic.
- .5 Verify adequacy of existing roads and allowable load limit on these roads. Contractor is responsible for repair of all damage to roads caused by construction operations.
- .6 Construct new access and haul roads as necessary.
- .7 Provide necessary lighting, signs, barricades, and distinctive markings for safe movement of traffic.
- .8 Dust control: adequate to ensure safe operation at all times.
- .9 Location, grade, width, and alignment of construction and hauling roads are subject to approval by Departmental Representative prior to construction of such roads.
- .10 Provide snow removal as required during period of Work. CSC will provide snow clearing of the roads in winter months to ensure Contractor access to the site.

1.13 CLEAN-UP

- .1 Remove daily construction debris, waste materials, packaging material from work site.
- .2 Clean dirt or mud tracked onto paved or surfaced roadways.
- .3 Store materials resulting from demolition activities that are salvageable, as directed by Departmental Representative.
- .4 Do not stack or store new or salvaged material within the restricted areas or inside Institution fence lines. Material storage to be located remote from institution security fence as directed by Departmental Representative.

2. PRODUCTS

2.1 NOT APPLICABLE.

3. EXECUTION

3.1 TEMPORARY EROSION AND SEDIMENTATION CONTROL

- .1 Provide temporary erosion and sedimentation control measures to prevent soil erosion and discharge of soil-bearing water runoff or airborne dust to adjacent properties and walkways, according to requirements of authorities having jurisdiction, specific to the site that complies with EPA 832/R-92-005 or requirements of authorities having jurisdiction, whichever is more stringent.
- .2 Inspect, repair, and maintain erosion and sedimentation control measures during construction until permanent vegetation has been established.

- .3 Remove erosion and sedimentation controls and restore and stabilize areas disturbed during removal.

END OF SECTION

1. GENERAL

1.1 INSTALLATION AND REMOVAL

- .1 Provide temporary barriers and controls in order to execute Work in a safe and secure manner.
- .2 All temporary barriers and enclosures to conform to the requirements and approval of the Departmental Representative.
- .3 Completely remove from site all such work after use.

1.2 HOARDING

- .1 Erect temporary site enclosures using 38 x 89 mm construction grade lumber framing at 610 mm centers and 1219 x 2438 x 12.7 mm exterior grade plywood to CSA O121.
- .2 Apply plywood panels vertically, flush and butt jointed.
- .3 Provide lockable truck entrance as required / needed and at least one pedestrian door as directed and conforming to applicable traffic restrictions on adjacent streets. Equip entrances with locks and keys.
- .4 Erect and maintain pedestrian walkways including roof and side covers, complete with signs and electrical lighting as required by law.
- .5 Maintain public side of enclosure in good repair and clean condition.
- .6 Erect temporary site barriers using new 1.2 m high snow fence wired to rolled steel "T" bar fence posts spaced at 2.4 m on centre, around excavations and site fixtures for safety, and to protect features from damage during construction. Maintain fence in good repair.
- .7 Provide barriers around trees and plants designated to remain. Protect from damage by equipment and construction procedures.

1.3 GUARD RAILS AND BARRICADES

- .1 Provide secure, rigid guard rails and barricades around deep excavations.
- .2 Provide as required by OH&S and governing authorities.

1.4 WEATHER ENCLOSURES

- .1 Provide hoarding when necessary to protect concrete work in cold weather conditions.
- .2 Provide temporary heat as required by propane fired units or similar equipment.
- .3 Design enclosures to withstand wind pressure and snow loading.

1.5 DUST TIGHT SCREENS

- .1 Provide dust tight screens or partitions to localize dust generating activities, and for the protection of workers.
- .2 Maintain and relocate protection until such work is complete.

1.6 ACCESS TO SITE

- .1 Provide and maintain access roads, sidewalk crossings, ramps and construction runways as may be required for access to Work.

1.7 PUBLIC TRAFFIC FLOW

- .1 Provide and maintain competent signal flag operators, traffic signals, barricades and flares, lights, or lanterns as required to perform Work and protect public and to maintain unimpeded access to the Institution.

1.8 FIRE ROUTES

- .1 Maintain access to institution property including overhead clearances for use by emergency response vehicles.

1.9 PROTECTION FOR OFF-SITE AND PUBLIC PROPERTY

- .1 Protect surrounding private and public property from damage during performance of Work.
- .2 Be responsible for all damage incurred as a result of the work or activities of the Contractor.

1.10 PROTECTION OF NEW FINISHES

- .1 Provide protection for finished and partially finished project features during performance of Work.
- .2 Provide necessary screens, covers, and hoardings.
- .3 Confirm with Departmental Representative locations and installation.
- .4 Be responsible for damage incurred due to lack of or improper protection.

1.11 WASTE MANAGEMENT AND DISPOSAL

- .1 Separate waste materials for reuse and recycling in accordance with Section 01 74 21 Construction Demolition.

END OF SECTION

1. GENERAL

1.1 PRODUCT REQUIREMENTS

- .1 Use only new material and equipment unless otherwise specified.
- .2 Within seven days of written request by Departmental Representative, submit following information for any materials and products proposed for supply and installation:
 - .1 Name and address of manufacturer.
 - .2 Trade name, model and catalogue number.
 - .3 Performance, descriptive and test data.
 - .4 Manufacturer's installation or application instructions.
 - .5 Evidence of arrangements to procure.
 - .6 Evidence of manufacturer delivery problems or anticipated delay.
- .3 Provide material and equipment of specified design and quality, performing to published ratings and for which replacement parts are readily available.
- .4 Use products of one manufacturer for equipment or material of same type or classification unless otherwise specified.
- .5 Permanent labels, trademarks and nameplates on products are not acceptable in prominent locations, except where required for operating instructions, or when located in mechanical or electrical rooms.
- .6 Reuse existing fence components where indicated and as directed, when existing components are in good reusable condition as per drawings and CSC Technical Criteria. Replace existing components that are bent, rusted or otherwise damaged, unusable or unsightly, with new components of equal size, capacity and finish as per drawings and CSC Technical Criteria.

1.2 PRODUCT QUALITY & REFERENCED STANDARDS

- .1 Section 01 00 10 – General Instructions.

1.3 PRODUCT QUALITY & REFERENCED STANDARDS

- .1 Contractor shall be solely responsible for submitting relevant technical data and independent test reports to confirm whether a product or system proposed for use meets contract requirements and specified standards.
- .2 Final decision as to whether a product or system meets contract requirements rest solely with the Departmental Representative in accordance with the General Conditions.

- .3 Products, materials, equipment and articles incorporated in Work shall be new, not damaged or defective, and of best quality for purpose intended. If requested, furnish evidence as to type, source and quality of products provided.
- .4 Defective products, whenever identified prior to completion of Work, will be rejected, regardless of previous inspections. Inspection does not relieve responsibility of the Contractor. Contractor will remove and replace defective products and materials at own expense and be responsible for subsequent delays and expenses.
- .5 Should disputes arise as to quality or fitness of products, decision rests strictly with Departmental Representative based upon requirements of Contract Documents.

1.4 AVAILABILITY

- .1 Immediately upon signing Contract, review product delivery requirements and advise foreseeable supply delays for items. If delays in supply of products are foreseeable, notify Departmental Representative of such in order that substitutions or other remedial action may be authorized in sufficient time to prevent delay in performance of Work. Provide supporting documentation as per clause 1.1.2.6 above.
- .2 In the event of failure to notify Departmental Representative at commencement of Work, and should it subsequently appear that Work may be delayed for such reason, Departmental Representative reserves right to substitute more readily available, similar or equivalent products at no increase in Contract Price or extension of Contract Time.

1.5 STORAGE, HANDLING AND PROTECTION

- .1 Handle and store products in manner to prevent damage, adulteration, deterioration and soiling, in accordance with manufacturer's instructions when applicable.
- .2 Store packaged or bundled products in original and undamaged condition with manufacturer's seal and labels intact. Do not remove from packaging or bundling until required in Work.
- .3 Store products subject to damage from weather in weatherproof enclosures.
- .4 Store cementitious products clear of earth or concrete floors, and away from walls.
- .5 Keep sand, when used for concrete, grout or mortar materials, clean and dry. Store sand on wooden platforms and cover with waterproof tarpaulins during inclement weather.
- .6 Remove and replace damaged products at own expense and to satisfaction of Departmental Representative.
- .7 Touch-up damaged factory finished surfaces to Departmental Representative's satisfaction. Use touch-up materials to match original. Do not paint over name plates or product data information.

1.6 MANUFACTURER'S INSTRUCTIONS

- .1 Unless otherwise indicated in the specifications, install or erect products in accordance with manufacturer's written instructions. Do not rely on labels or enclosures provided with products. Obtain written instructions directly from product manufacturers.
- .2 Notify Departmental Representative in writing, of conflicts between specifications and manufacturer's instructions, to enable the Departmental Representative to establish a course of action.
- .3 Improper installation or erection of products, due to failure in complying with these requirements, authorizes the Departmental Representative to require removal and re-installation at no increase in Contract Price or extension of the Contract Time.

1.7 WORKMANSHIP

- .1 Ensure quality of work is of highest standard, executed by workers experienced and certified in their respective trades and duties for which they are employed.
- .2 Remove unsuitable or incompetent workers from site.
- .3 Ensure cooperation of workers in laying out work. Maintain efficient and continuous supervision on site at all times.
- .4 Coordinate work between trades and subcontractors as noted in Section 01 00 10 General Conditions.
- .5 Coordinate placement of openings, sleeves, conduit and accessories.

1.8 LOCATION OF FIXTURES

- .1 Consider location of existing and new structural, mechanical and electrical items.
- .2 Inform Departmental Representative of conflicting installation. Install where / as directed.

1.9 FASTENINGS GENERAL

- .1 Provide metal fastenings and accessories in same texture, colour and finish as adjacent materials as specified, unless indicated otherwise.
- .2 Prevent electrolytic action between dissimilar metals and materials.
- .3 Use non-corrosive hot dip galvanized steel fasteners and anchors for securing exterior work, unless stainless steel or other material is specified.
- .4 Space anchors within individual load limit or shear capacity and ensure they provide positive permanent anchorage. Wood or any other organic anchor materials are not acceptable.
- .5 Keep exposed fastenings to a minimum, space evenly and install neatly.

- .6 Fastenings which cause spalling or cracking of new or existing concrete are not acceptable.
- .7 Do not use explosive actuated fastening devices unless specifically recommended by Departmental Representative and approved by the Director. See Section 01 14 10 Security Restrictions.

1.10 FASTENINGS - EQUIPMENT

- .1 Use fastenings of standard commercial sizes and patterns with material and finish suitable for service.
- .2 Use heavy hexagon heads, semi-finished unless otherwise specified. Use No. 304 stainless steel for exterior areas.
- .3 Bolts may not project more than one diameter beyond nuts.
- .4 Use plain type washers on equipment, sheet metal and soft gasket lock type washers where vibrations occur. Use resilient washers with stainless steel.
- .5 Fasteners and supplied materials are to meet or exceed requirements in the CSC Technical Criteria.

1.11 PROTECTION OF WORK IN PROGRESS

- .1 Prevent overloading of adjacent existing fixtures or components. Do not cut, drill or sleeve load bearing structural member, without written approval of Departmental Representative.

1.12 CONSTRUCTION EQUIPMENT

- .1 Upon request of the Departmental Representative, provide evidence that the construction equipment and components are adequate to manufacture, transport, place and finish work to quality and production rates specified. If inadequate, replace or provide additional equipment as directed.
- .2 Maintain construction equipment in good operating order.

END OF SECTION

1. GENERAL

- .1 Conduct cleaning and disposal operations to comply with local ordinances and antipollution laws.
- .2 Store volatile, flammable, or toxic waste in covered metal containers, and remove from premises at end of each working day.
- .3 Dispose of all materials as directed in 01 35 43 Environmental Procedures.

1.2 MATERIALS

- .1 Use only cleaning materials recommended by manufacturer of item or surface to be cleaned, and type as recommended by cleaning material manufacturer.

1.3 PROJECT CLEANLINESS

- .1 Maintain Work in tidy condition, free from accumulation of waste products and debris.
- .2 Remove waste materials from site at daily regularly scheduled times or dispose as directed by Departmental Representative.
- .3 Do not burn or bury waste materials on site.
- .4 Make arrangements and obtain permits from authorities having jurisdiction for disposal of waste and debris.
- .5 Provide on-site containers or dumpsters for collection of waste materials and debris. Waste containers shall be located outside the security fence area.
- .6 Use separate collection bins, clearly marked as to purpose, for the collection of specified recycle materials and waste.
- .7 Schedule cleaning operations so that resulting dust, debris and other contaminants will not fall on wet, newly painted surfaces nor contaminate adjacent areas, soil, foliage, site fixtures or buildings.

1.4 FINAL CLEANING

- .1 In preparation for acceptance of the project on an Interim or Final Certificate of Completion perform final cleaning of all new construction and adjacent areas affected by construction activities.

END OF SECTION

1. GENERAL

1.1 WASTE MANAGEMENT GOALS

- .1 Prior to start of Work conduct meeting with Departmental Representative and the Consultant to review and discuss PWGSC's Waste Management Plan and Goals. This topic is expected to be included in the Pre-Construction Meeting.
- .2 PWGSC's Waste Management Goal is that 75 percent of total Project Waste is to be diverted from landfill sites. Provide Departmental Representative and Consultant documentation certifying that waste management, recycling, reuse of recyclable and reusable materials have been extensively practiced.
- .3 Accomplish maximum control of solid construction waste.
- .4 Preserve environment and prevent pollution and environment damage.

1.2 DEFINITIONS

- .1 Class III: non-hazardous waste - construction renovation and demolition waste.
- .2 Cost/Revenue Analysis Workplan (CRAW): based on information from Waste Reduction Workplan (WRW), and intended as financial tracking tool for determining economic status of waste management practices.
- .3 Demolition Waste Audit (DWA): relates to actual waste generated from project.
- .4 Inert Fill: inert waste - exclusively asphalt and concrete.
- .5 Materials Source Separation Program (MSSP): consists of series of ongoing activities to separate reusable and recyclable waste material into material categories from other types of waste at point of generation.
- .6 Recyclable: ability of product or material to be recovered at end of its life cycle and re-manufactured into new product for reuse.
- .7 Recycle: process by which waste and recyclable materials are transformed or collected for purpose of being transferred into new products.
- .8 Recycling: process of sorting, cleansing, treating and reconstituting solid waste and other discarded materials for purpose of using in altered form. Recycling does not include burning, incinerating, or thermally destroying waste.
- .9 Reuse: repeated use of product in same form but not necessarily for same purpose. Reuse includes:
 - .1 Salvaging reusable materials from re-modeling and renovation projects, before demolition stage, for resale, reuse on current project or for storage for use on future projects.
 - .2 Returning reusable items including pallets or unused products to vendors.

- .10 Salvage: removal of structural and non-structural materials from deconstruction/disassembly projects for purpose of reuse or recycling.
- .11 Separate Condition: refers to waste sorted into individual types.
- .12 Source Separation: the act of keeping different types of waste materials separate, beginning from first time they became waste.
- .13 Waste Audit (WA): detailed inventory of materials. Involves quantifying by volume/weight amounts of materials and wastes generated during construction, demolition, deconstruction, or renovation project. Indicates quantities of reuse, recycling and landfill. Refer to Schedule A.
- .14 Waste Management Coordinator (WMC): contractor representative responsible for supervising waste management activities as well as coordinating related, required submittal and reporting requirements.
- .15 Waste Reduction Workplan (WRW): written report which addresses opportunities for reduction, reuse, or recycling of materials. Refer to Schedule B. WRW is based on information acquired from WA (Schedule A).

1.3 WASTE REDUCTION WORKPLAN (WRW)

- .1 Prepare Waste Reduction Workplan (WRW) prior to project start-up. A copy of the WRW is to be provided to the Departmental Representative.
- .2 WRW should include but is not limited to:
 - .1 Destination of materials listed.
 - .2 Deconstruction/disassembly techniques and sequencing.
 - .3 Schedule for deconstruction/disassembly.
 - .4 Location.
 - .5 Security.
 - .6 Protection.
 - .7 Clear labeling of storage areas.
 - .8 Details on materials handling and removal procedures.
 - .9 Quantities for materials to be salvaged for reuse or recycled and materials sent to landfill.
- .3 Structure WRW to prioritize actions and follow 3R's hierarchy, with Reduction as first priority, followed by Reuse, then Recycle.
- .4 Describe management of waste.

- .5 Identify opportunities for reduction, reuse, and recycling of materials. Based on information acquired from WA.
- .6 Inform all workers and post WRW or summary where workers at site are able to review content.
- .7 Monitor and report on waste reduction by documenting total volume and cost of actual waste removed from project.

1.4 DEMOLITION WASTE AUDIT (DWA)

- .1 Prepare DWA prior to project start-up. A copy of the DWA is to be provided to the Departmental Representative.
- .2 Complete DWA: Schedule C.
- .3 Provide inventory of quantities of materials to be salvaged for reuse, recycling, or disposal.

1.5 MATERIALS SOURCE SEPARATION PROGRAM (MSSP)

- .1 Prepare MSSP and have ready for use prior to project start-up. A copy of the MSSP is to be provided to the Departmental Representative.
- .2 Implement MSSP for waste generated on project in compliance with approved methods and as reviewed by Departmental Representative.
- .3 Provide on-site facilities for collection, handling, and storage of anticipated quantities of reusable and recyclable materials.
- .4 Provide containers to deposit reusable and recyclable materials.
- .5 Locate containers in locations, to facilitate deposit of materials without hindering daily operations.
- .6 Locate separated materials in areas which minimize material damage.
- .7 Collect, handle, store on-site, and transport off-site, salvaged materials in separate condition.
 - .1 Transport to approved and authorized recycling facility or to users of material for recycling.
- .8 Collect, handle, store on-site, and transport off-site, salvaged materials in combined condition.
 - .1 Ship material to site operating under Certificate of Approval.
 - .2 Materials must be immediately separated into required categories for reuse or recycling.

1.6 WASTE PROCESSING SITES

- .1 Province of Alberta: Contractor to provide name, location and contact information of the site.

1.7 STORAGE, HANDLING AND PROTECTION

- .1 Store, materials to be reused, recycled and salvaged in locations as directed by Departmental Representative.
- .2 Unless specified otherwise, materials for removal become Contractor's property.
- .3 Protect, stockpile, store and catalogue salvaged items.
- .4 Separate non-salvageable materials from salvaged items. Transport and deliver non-salvageable items to licensed disposal facility.
- .5 Protect structural components not removed for demolition from movement or damage.
- .6 Support affected structures. If safety of structure or persons is endangered, cease operations and immediately notify Departmental Representative.
- .7 Protect surface drainage, mechanical and electrical from damage and blockage.
- .8 Separate and store materials produced during dismantling of structures in designated areas.
- .9 Prevent contamination of materials to be salvaged and recycled and handle materials in accordance with requirements for acceptance by designated facilities.
 - .1 On-site source separation is recommended.
 - .2 Remove co-mingled materials to off-site processing facility for separation.
 - .3 Provide waybills for separated materials.

1.8 DISPOSAL OF WASTES

- .1 Do not bury rubbish or waste materials on site.
- .2 Do not dispose of waste, volatile materials, mineral spirits, oil, paint thinner, etc. into waterways, storm, or sanitary sewers.
- .3 Keep records of construction waste including:
 - .1 Number and size of bins.
 - .2 Waste type of each bin.
 - .3 Total tonnage generated.
 - .4 Tonnage reused or recycled.

- .5 Reused or recycled waste destination.
- .4 Remove materials from deconstruction as deconstruction/disassembly Work progresses.
- .5 Prepare project summary to verify destination and quantities on a material-by-material basis as identified in pre-demolition material audit.

1.9 USE OF SITE AND FACILITIES

- .1 Execute work with least possible interference or disturbance to normal use of premises.
- .2 Maintain security measures established by existing facility, or provide temporary security measures approved by Departmental Representative.

1.10 SCHEDULING

- .1 Co-ordinate Work with other activities at site to ensure timely and orderly progress of Work.

2. EXECUTION

2.1 SELECTIVE DEMOLITION

- .1 Reuse of project elements: this project has been designed to result in end of project rates for reuse of elements as follows: do not demolish fence elements beyond what is indicated on Drawings without approval by Departmental Representative.

2.2 APPLICATION

- .1 Do all Work in compliance with WRW.
- .2 Handle waste materials not reused, salvaged, or recycled in accordance with appropriate regulations and codes.

2.3 CLEANING

- .1 Remove tools and waste materials on completion of Work, and leave work area in clean and orderly condition.
- .2 Clean-up work area as work progresses, conforming to Section 01 74 11.
- .3 Source separate materials to be reused/recycled into specified sort areas.

2.4 DIVERSION OF MATERIALS

- .1 From following list, separate materials from general waste stream and stockpile in separate piles or containers, as reviewed by Departmental Representative, and consistent with applicable fire regulations.
 - .1 Mark containers or stockpile areas.
 - .2 Provide instruction on disposal practices.

- .2 On-site sale of salvaged, recovered, reusable, recyclable material is not permitted.
- .3 Demolition Waste:

DEMOLITION WASTE		
Material Type	Recommended Diversion %	Actual Diversion %
Electrical Equipment	80	
Metals	100	
Rubble	100	
Asphalt	100	
Concrete	100	

- .4 Construction Waste

CONSTRUCTION WASTE		
Material Type	Recommended Diversion %	Actual Diversion %
Cardboard	80	
Plastic Packaging	100	
Rubble	100	
Steel	100	
Other	100	

2.5 WASTE REDUCTION WORKPLAN (WRW)

Material Category	Person Responsible	Est. Total Quantity (units)	Actual Quantity (units)	Recycled (units)	Reused (units)	Disposed (units)
Wood						
Forms						
Plastics						
Packaging						
Cardboard						
Metals						
Other						

2.6 DEMOLITION WASTE AUDIT (DWA)

Material Description	Quantity (units)	Unit	Total	Volume (cumulative)	Weight (cumulative)	Remarks and Assumptions
Wood						
Forms						
Plastics						
Packaging						
Cardboard						
Metals						
Other						

2.7 CANADIAN GOVERNMENTAL DEPARTMENTS CHIEF RESPONSIBILITY FOR THE ENVIRONMENT

.1 Schedule E - Government Chief Responsibility for the Environment:

Province: Alberta

Address: Environmental Protection
Petroleum Plaza South Tower
9915 - 108th Street
Edmonton, AB
T5K 2G8

General Inquiries: 403-427-2739

Fax Inquiries: 403-422-5029
403-428-9627

END OF SECTION

1. GENERAL

1.1 ADMINISTRATIVE REQUIREMENTS

- .1 Acceptance of Work Procedures:
 - .1 Contractor's Inspection: Contractor: conduct inspection of Work, identify deficiencies and defects, and repair as required to conform to Contract Documents.
 - .1 Notify Departmental Representative in writing of satisfactory completion of Contractor's inspection, and submit verification that corrections have been made.
 - .2 Request Departmental Representative inspection.
 - .2 Departmental Representative Inspection:
 - .1 Departmental Representative and Contractor to inspect Work and identify defects and deficiencies.
 - .2 Contractor to correct Work as directed.
 - .3 Completion Tasks: submit written certificates in English that tasks have been performed as follows:
 - .1 Work: completed and inspected for compliance with Contract Documents.
 - .2 Defects: corrected and deficiencies completed.
 - .3 Equipment and systems: tested, adjusted and fully operational.
 - .4 Operation of systems: demonstrated to Owner's personnel.
 - .5 Work: complete and ready for final inspection.
 - .4 Final Inspection:
 - .1 When completion tasks are done, request final inspection of Work by Departmental Representative, Consultant, and Contractor.
 - .2 When Work is found to be incomplete according to Departmental Representative or Consultant, complete outstanding items and request re-inspection.
 - .5 Declaration of Substantial Performance: when Departmental Representative considers deficiencies and defects corrected and requirements of Contract substantially performed, make application for Certificate of Substantial Performance.

- .6 Commencement of Lien and Warranty Periods: date of Owner's acceptance of submitted declaration of Substantial Performance to be date for commencement for warranty period and commencement of lien period unless required otherwise by lien statute of Place of Work.
- .7 Final Payment:
 - .1 When Departmental Representative considers final deficiencies and defects corrected and requirements of Contract met, make application for final payment.
- .8 Payment of Holdback: after issuance of Certificate of Substantial Performance of Work, submit application for payment of holdback amount in accordance with contractual agreement.

1.2 FINAL CLEANING

- .1 Clean in accordance with Section 01 74 11 - Cleaning.
 - .1 Remove surplus materials, excess materials, rubbish, tools and equipment.
- .2 Waste Management: separate waste materials for reuse and recycling in accordance with Section 01 74 21 – Construction Demolition

END OF SECTION

1. GENERAL

1.1 PROJECT RECORD DOCUMENT

- .1 The Contractor will provide two white print sets of contract drawings and two copies of Specifications Manual specifically for "As-built" purposes.
- .2 Maintain at the site one set of the contract drawings and specifications to record actual "As-built" site conditions.
- .3 Maintain up-to-date, real time "As-built" drawings and specifications at the site, and make available for inspection by the Departmental Representative at any time during construction.
- .4 As-Built Drawings:
 - .1 Contractor to record all construction changes in red ink on the prints. Mark only on one set of prints and at completion of project and prior to final inspection, neatly transfer notations to second set (also by use of red ink). Submit both sets to the Departmental Representative. All drawings of both sets shall be stamped "As-Built Drawings" and be signed and dated by Contractor.
 - .2 Show all modifications, substitutions and deviations from what is shown on the contract drawings or in specifications.
 - .3 Record following information:
 - .1 Depths of various elements of concrete anti-tunneling walls in relation to existing structures and grade.
 - .2 Size and location of all new fence posts in relation to existing benchmarks or buildings.
 - .3 Horizontal and vertical location of all new elements in relation to Geodetic Datum;
 - .4 Horizontal and vertical location of exterior underground utilities and appurtenances referenced to permanent surface improvements, when applicable.
 - .5 Location of internal electrical conduit concealed in concrete construction and/or below grade, referenced to existing accessible features;
 - .6 Field changes of dimensions and details;
 - .7 All Change Orders issued over the course of the contract must be documented on the finished As-built documents, accurately and consistently depicting the changed condition as it applies to all affected drawing details.

- .8 Any details produced in the course of the contract by the Departmental Representative to supplement or to change existing design drawings must also be marked and dimensioned to reflect final As-built conditions and appended to the as-built drawing document.
- .5 As-built Specifications: Legibly mark in red each item to record actual construction, including:
 - .1 Manufacturer, trade name, and catalogue number of each product actually installed, particularly all deviations from the specifications.
 - .2 All changes made by Addenda and Change Orders.
 - .3 Mark up both copies of specifications; stamp "As-built", sign and date similarly to drawings as noted above.
- .6 Maintain As-built record documents current as the contract progresses. Frequency of review of the As-built documents will be subject to Departmental Representative's discretion. Failure to maintain As-built documents current and complete to satisfaction of the Departmental Representative shall be subject to financial penalties in the form of progress payment reductions and holdback assessments.
- .7 At project completion, all 'As-Built' drawings and specifications will be submitted to the Departmental Representative. These documents will be used to create 'Record Drawings'.

1.2 REVIEWED SHOP DRAWINGS

- .1 Compile one full set of all reviewed and approved shop drawings. Provide number of shop drawing sets equal to the required number of final Operations and Maintenance manuals.
- .2 Shop drawing sets to be included with the contents of the Operation and Maintenance Manuals as specified below.

1.3 OPERATION AND MAINTENANCE MANUAL

- .1 Definition: An organized compilation of operating and maintenance data including detailed technical information, catalogue cut sheets, brochures, shop drawings, manufacturers drawings, documents and records describing the function, operation and maintenance of individual products, systems or components as specified in the individual sections of the specifications.
- .2 Manual Language: Final O&M Manuals to be in English, supplemented with French when available or provided by the manufacturer.
- .3 Number of copies required:
 - .1 Submit 2 initial copies as well as an electronic copy of the manual for review and inspection by Departmental Representative. Make revisions, corrections and additions as directed by the Departmental Representative and resubmit.

- .2 Upon final review and acceptance by the Departmental Representative, submit three (3) final complete copies as well as an electronic copy. Initial copies will not be considered as final copies unless they are identical to the final approved version.
- .4 Submission Date: submit all three copies of the complete Operation and Maintenance Manuals to the Departmental Representative six (6) weeks prior to application for Interim Certificate of Completion of project.
- .5 Binding:
 - .1 Assemble, coordinate, bind and index all required data into Operation and Maintenance Manuals.
 - .2 Use only hard covered vinyl, three inch "D" ring binders, loose leaf sheets sized for 215 x 280 mm paper, with inside cover pockets and spine pocket. Cover and spine to contain title page with project information, including project title, date, name of contractor, Consultant and owner.
 - .3 Where multiple binders are needed, correlate data into related consistent groupings, i.e. Civil, Structural, and Electrical.
 - .4 Organize and divide data into sections same as Specification division numerical order of contract specifications and thereafter subdivided into various equipment systems.
 - .5 Material: separate each section by use of cardboard dividers and labels. Provide tabbed fly leaf for each separate product or system within each section and with typed description of product and major components / parts of equipment.
 - .6 Lists and notes to be typewritten. Do not hand write.
 - .7 Drawings, diagrams and manufacturers' literature must be clear legible. Provide with reinforced, punched binder tab. Bind in with text; fold larger drawings to suit the binder.
- .6 Manual Contents:
 - .1 Cover sheet containing:
 - .1 Project title, location and project number;
 - .2 Date submitted;
 - .3 Names and contact information of Prime Contractor, and all Sub-contractors.
 - .2 Table of Contents sheet: provide full table of contents in each binder(s), clearly indicate which contents are in each binder.
 - .3 List of maintenance materials.

- .4 List of spare parts.
- .5 List of special tools.
- .6 Original or certified copy of Warranties and Guarantees.
- .7 Copies of approvals, and certificates issued by Inspection Authorities.
- .8 Copies of reports and results from tests designated as Contractor's responsibilities.
- .9 Data on all products, equipment and systems as specified in individual sections of the specifications to include:
 - .1 List of equipment including manufacturer's name, supplier, local source of supplies and service depot(s). Provide full addresses and telephone numbers.
 - .2 Nameplate information including equipment number, make, size, capacity, model number and serial number.
 - .3 Parts list.
 - .4 Installation details.
 - .5 Operating instructions.
 - .6 Maintenance instructions for equipment.
 - .7 Maintenance instructions for finishes.
- .7 Shop drawings:
 - .1 Bind separately one complete set of reviewed shop drawings and product data for each Operations and Maintenance manual required.
 - .2 Bind the shop drawings in a manner such that they correspond with the appropriate specification section.
- .8 Equipment and Systems Data: the following list indicates the type of data and extent of information required to be included for each item of equipment and for each system:
 - .1 Description of unit or system, and component parts. Give function, normal operation characteristics, and limiting conditions. Include performance curves, with engineering data and tests, and complete nomenclature and commercial number of replaceable parts.
 - .2 Panel board circuit Directories: provide electrical service characteristics, controls, and communications.
 - .3 Include installed colour coded wiring diagrams.

- .4 Operating Procedures: include start-up, break-in, and routine normal operating instructions and sequences. Include regulation, control, stopping, shut-down, and emergency instructions. Include summer, winter, and any special operating instructions.
- .5 Maintenance Requirements: include routine procedures and guide for troubleshooting; disassembly, repair, and reassembly instructions; and alignment, adjusting, balancing, and checking instructions.
- .6 Servicing and lubrication schedule and list of lubricants required.
- .7 Manufacturer's printed operation and maintenance instructions.
- .8 Sequence of operation by controls manufacturer.
- .9 Provide original manufacturer's parts list, illustrations, assembly drawings, and diagrams required for maintenance.
- .10 Provide installed control diagrams by controls manufacturer.
- .11 Provide Contractor's co-ordination drawings, with installed colour coded piping diagrams.
- .12 Provide list of original manufacturer's spare parts, current prices, and recommended quantities to be maintained in storage.
- .13 Include test reports.
- .14 Additional requirements as specified in individual specification sections.
- .9 Materials and Finishes Maintenance Data:
 - .1 Instructions for cleaning agents and methods, precautions against detrimental agents and methods, and recommended schedule for cleaning and maintenance.
 - .2 Moisture-protection and weather-exposed products: include manufacturer's recommendations for cleaning agents and methods, precautions against detrimental agents and methods, and recommended schedule for cleaning and maintenance.
 - .3 Additional requirements: as required in individual specifications sections.

1.4 MAINTENANCE MATERIALS

- .1 Provide maintenance and extra materials, in quantities specified in individual specification sections.
- .2 Provide items of same manufacture and quality as items in Work.
- .3 Clearly mark on container or packaging information as to content, quantity, colour, location, system or area as applicable where item is used.

- .4 Deliver to site. Store in location as directed by Departmental Representative.
- .5 Receive and catalogue all items. Prepare inventory list.
- .6 Submit copy of inventory list to the Departmental Representative. Include approved listings in Operations and Maintenance Manual.

END OF SECTION

1. GENERAL

1.1 RELATED REQUIREMENTS

- .1 Section 03 30 00 – Cast in Place Concrete.

1.2 ACTION AND INFORMATIONAL SUBMITTALS

- .1 Submit in accordance with Section 01 33 10 - Submittal Procedures.
- .2 Shop Drawings:
 - .1 Submit drawings stamped and signed by professional engineer registered or licensed in Province of Alberta of Canada.
 - .1 Indicate placing of reinforcement and:
 - .1 Bar bending details.
 - .2 Lists.
 - .3 Quantities of reinforcement.
 - .4 Sizes, spacing, locations of reinforcement and mechanical splices if approved by Departmental Representative, with identifying code marks to permit correct placement without reference to structural drawings.
 - .5 Indicate sizes, spacing and locations of chairs, spacers and hangers.

1.3 QUALITY ASSURANCE

- .1 Submit in accordance with Section 01 45 00 - Quality Control.
- .2 Upon request submit in writing to Departmental Representative proposed source of reinforcement material to be supplied.

1.4 DELIVERY, STORAGE AND HANDLING

- .1 Deliver, store and handle reinforcing steel in accordance with manufacturer's written instructions to prevent damage.
- .2 Delivery and Acceptance Requirements: deliver materials to site in original factory packaging, labeled with manufacturer's name and address.
- .3 Storage and Handling Requirements:
 - .1 Store materials off ground and in accordance with manufacturer's recommendations. Place timber pallets under bars to keep them free from dirt and mud and to provide ease of handling.

- .2 Replace defective or damaged materials with new.
- .3 Remove defective bars and components from the site.

2. PRODUCTS

2.1 MATERIALS

- .1 Use steel reinforcement GRADE 400R or Grade 400W.
- .2 Substitute different size bars only if permitted in writing by Departmental Representative.
- .3 Field bending is not permitted.
- .4 Chairs, bolsters, bar supports, spacers, and ties: Use non steel materials from approved supplier.
- .5 Mechanical splices: No mechanical splicing is allowed. Overlap length is 40 times bar diameter.

2.2 FABRICATION

- .1 Ship bundles of bar reinforcement, clearly identified in accordance with bar bending details and lists.

3. EXECUTION

3.1 PLACING REINFORCEMENT

- .1 Place reinforcing bars as indicated on drawings.
- .2 Prior to placing concrete, obtain Departmental Representative's approval of reinforcing material and placement.
- .3 Ensure cover to reinforcement is maintained during concrete pour.

3.2 CLEANING

- .1 Progress Cleaning: Clean in accordance with Section 01 74 11 - Cleaning. Leave Work area clean at end of each day.
- .2 Final Cleaning: Upon completion remove surplus materials, rubbish, tools and equipment in accordance with Section 01 74 11 - Cleaning.

END OF SECTION

1. GENERAL

1.1 REFERENCES

- .1 Abbreviations and Acronyms:
 - .1 Cement: Type HS - High sulphate-resistant cement.
- .2 Reference Standards:
 - .1 ASTM International
 - .1 ASTM C 260-06, Standard Specification for Air-Entraining Admixtures for Concrete.
 - .2 ASTM C 494/C 494M-(08a), Standard Specification for Chemical Admixtures for Concrete.
 - .3 ASTM Standards where noted.
 - .2 CSA International
 - .1 CSA A23.1/A23.2-2009, Concrete Materials and Methods of Concrete Construction/Methods of Test and Standard Practices for Concrete.
 - .2 CSA A283-(06), Qualification Code for Concrete Testing Laboratories.
 - .3 CSA A3000-(08), Cementitious Materials Compendium (Consists of A3001, A3002, A3003, A3004 and A3005).

1.2 RELATED REQUIREMENTS

- .1 Section 01 45 00 – Quality Control.
- .2 Section 01 74 11 – Cleaning.
- .3 Section 03 20 00 – Concrete Reinforcing.

1.3 ACTION AND INFORMATIONAL SUBMITTALS

- .1 Provide submittals in accordance with Section 01 33 10 - Submittal Procedures.
- .2 Provide testing results and reports for review by Departmental Representative and do not proceed without written approval when deviations from mix design or parameters are found.
- .3 Submit data on all concrete accessories specified or proposed.
- .4 Submit all curing procedures.

- .5 Submit proposed methods or protection of concrete when air temperatures are expected to be above +25°C or below + 5°C.

1.4 QUALITY ASSURANCE

- .1 Quality Assurance: in accordance with Section 01 45 00 - Quality Control.
- .2 Provide Departmental Representative, minimum one week prior to starting concrete work, with valid and recognized certificate from plant delivering concrete.
 - .1 Provide test data and certification by qualified independent inspection and testing laboratory that materials and mix designs used in concrete mixture will meet specified requirements.
- .3 Minimum one week prior to commencing concrete work, provide proposed quality control procedures for review by Departmental Representative on following items:
 - .1 Hot weather concrete.
 - .2 Cold weather concrete.
 - .3 Curing.
 - .4 Finishes.
 - .5 Formwork removal.
- .4 Quality Control Plan: provide written report to Departmental Representative verifying compliance that concrete in place meets performance requirements of concrete as established in PART 2 - PRODUCTS.

1.5 DELIVERY, STORAGE AND HANDLING

- .1 Delivery and Acceptance Requirements:
- .2 Concrete hauling time: deliver to site of Work and discharged within 90 minutes maximum after batching.
 - .1 Do not modify maximum time limit without receipt of prior written agreement from Departmental Representative and concrete producer as described in CSA A23.1/A23.2.
 - .2 Deviations to be submitted for review by Departmental Representative.
- .3 Concrete delivery: ensure continuous concrete delivery from plant meets CSA A23.1/A23.2.

2. PRODUCTS

2.1 DESIGN CRITERIA

- .1 Performance: to CSA A23.1/A23.2, and as described in MIXES of PART 2 - PRODUCTS.

2.2 PERFORMANCE CRITERIA

- .1 Quality Control Plan: ensure concrete supplier meets performance criteria of concrete as established by Departmental Representative and provide verification of compliance as described in PART 1 - QUALITY ASSURANCE.

2.3 MATERIALS

- .1 Cement: to CSA A3001, Type HS.
- .2 Supplementary cementing materials: with (minimum 8% for Type CI and maximum 8% for Type F) fly ash replacement, by mass of total cementitious materials to CSA A3001.
- .3 Water: to CSA A23.
- .4 Aggregates: to CSA A23.1/A23.2.
- .5 Admixtures:
 - .1 Air entraining admixture: to ASTM C 260.
 - .2 Chemical admixture: to ASTM C 494. Departmental Representative to approve accelerating or set retarding admixtures during cold and hot weather placing.

2.4 MIXES

- .1 Performance Method for specifying concrete: to meet Departmental Representative performance criteria to CSA A23.1/A23.2.
 - .1 Ensure concrete supplier meets performance criteria as established below and provide verification of compliance as in Quality Control Plan.
 - .2 Provide concrete mixes to meet following hard state requirements:
 - .1 Compressive strength at 28 age: 32 MPa minimum for the concrete used in the fence, gates posts and anti-tunneling walls.
 - .2 Aggregate size 20 mm maximum.
 - .3 Provide quality management plan to ensure verification of concrete quality to specified performance.
 - .4 Concrete supplier's certification: both batch plant and materials meet CSA A23.1 requirements.
 - .5 Other performance requirements:
 - .1 Slump 75 +/- 25 mm.
 - .2 Air Content 4 to 7%.
 - .3 W/C max 0.4.

3. EXECUTION

3.1 PREPARATION

- .1 Obtain Departmental Representative's written approval before placing concrete.
 - .1 Provide 24 hours minimum notice prior to placing of concrete.
- .2 During concreting operations:
 - .1 Development of cold joints not allowed.
 - .2 Ensure concrete delivery and handling facilitates placing with minimum of re-handling, and without damage to existing structure or Work.
- .3 Ensure reinforcement and inserts are not disturbed during concrete placement.
- .4 Prior to placing of concrete obtain Departmental Representative's approval of proposed method for protection of concrete during placing and curing in adverse weather where temp is above + 25°C or below +5°C.
- .5 Protect previous or existing Work from staining.
- .6 Clean and remove stains prior to application for concrete finishes.
- .7 Maintain accurate records of poured concrete items to indicate date, location of pour, quality, air temperature and test samples taken.

3.2 INSTALLATION / APPLICATION

- .1 Do cast-in-place concrete work to CSA A23.1/A23.2.
- .2 Finishing and curing:
 - .1 Finish concrete to CSA A23.1/A23.2.
 - .2 Use procedures as reviewed by Departmental Representative or those noted in CSA A23.1/A23.2 to remove excess bleed water. Ensure surface is not damaged.
 - .3 Use curing compounds compatible with applied finish on concrete surfaces. Provide written declaration that compounds used are compatible.
 - .4 Provide float finish for the anti-tunneling concrete unless otherwise indicated.
 - .5 Provide 20mm chamfer on all exposed concrete edges.

3.3 FIELD QUALITY CONTROL

- .1 Site tests: conduct tests as follows in accordance with Section 01 45 00 - Quality Control and submit report as described in PART 1 - ACTION AND INFORMATIONAL SUBMITTALS.

- .1 Slump.
- .2 Air content.
- .3 Compressive strength at 7 and 28 days.
- .4 Air and concrete temperature.
- .2 Departmental Representative will take additional test cylinders during cold weather concreting. Cure cylinders on job site under same conditions as concrete which they represent.
- .3 Inspection or testing by Departmental Representative will not augment or replace Contractor quality control nor relieve Contractor of his contractual responsibility.

3.4 CLEANING

- .1 Clean in accordance with Section 01 74 11 - Cleaning.

END OF SECTION

1. GENERAL

1.1 REFERENCES

- .1 Master Painters Institute (MPI): Architectural Painting Specification Manual - current edition.
- .2 CSC Technical Criteria, March 2014

1.2 ACTION AND INFORMATIONAL SUBMITTALS

- .1 Submit in accordance with Section 01 33 10 - Submittal Procedures.
- .2 Shop Drawings:
 - .1 Submit drawings stamped and signed by a Professional Engineer registered or licensed in Province of Alberta, Canada.
 - .2 Indicate materials, core thicknesses, finishes, connections, joints, method of anchorage, number of anchors, supports, reinforcement, details, and accessories.

1.3 QUALITY ASSURANCE

- .1 Provide documentation showing compliance with specified performance characteristics and physical properties.

1.4 DELIVERY, STORAGE AND HANDLING

- .1 Deliver, store and handle materials in accordance with Section 01 61 00 - Common Product Requirements.
- .2 Deliver materials to site, labeled or identified with suppliers name and address.
- .3 Storage and Handling Requirements:
 - .1 Store materials off ground in a dry location as directed by the Departmental Representative.
 - .2 Protect from the weather, damage and vandalism before erection on site.

2. PRODUCTS

2.1 MATERIALS

- .1 Steel sections and plates: to CSA G40.20/G40.21, Grade 350W.
- .2 Steel pipe: to ASTM A 53/A 53M standard weight, galvanized finish.
- .3 Welding materials: to CSA W59.

- .4 Welding electrodes: to CSA W48 Series.
- .5 Bolts and anchor bolts: to ASTM A 307.
- .6 Grout: non-shrink, non-metallic, flowable, 15 MPa at 24 hours.

2.2 FABRICATION

- .1 Fabricate work square, true, straight and accurate to required size, with joints closely fitted and properly secured.
- .2 Welding: to CSA W59.
- .3 Use self-tapping shake-proof flat headed screws on items requiring assembly by screws or as indicated.
- .4 Fit and shop assemble frames work, ready for erection on site.
- .5 Ensure exposed welds are continuous for length of each joint. File or grind exposed welds smooth and flush.

2.3 FINISHES

- .1 Galvanizing: hot dipped galvanizing with zinc coating 600 g/m² to CAN/CSA-G164.
- .2 Shop coat primer: in accordance with chemical component limits and restrictions requirements and VOC limits of GS-11.
- .3 Zinc primer: zinc rich, ready mix, in accordance with chemical component limits and restrictions requirements and VOC limits of GS-11.

2.4 ISOLATION COATING

- .1 Isolate aluminum from following components, by means of bituminous paint:
 - .1 Dissimilar metals except stainless steel, zinc, or white bronze of small area.
 - .2 Concrete, mortar and masonry.

2.5 SHOP PAINTING

- .1 Primer: VOC limit 250 g/L maximum to GS-11.
- .2 Apply one shop coat of primer to metal items, with exception of galvanized or concrete encased items.
- .3 Use primer unadulterated, as prepared by manufacturer. Paint on dry surfaces, free from rust, scale, grease. Do not paint when temperature is lower than 7 degrees C.
- .4 Clean surfaces to be field welded; do not paint.

2.6 GATE FRAMES

- .1 Fabricate new gate frames from steel, sizes of members and details as indicated.
- .2 Weld steel members together to form frame components for Sallyport gates, to sizes and dimensions as indicated.
- .3 Finish: shop galvanized.

3. EXECUTION

3.1 EXAMINATION

- .1 Verification of Conditions: verify conditions of substrates previously installed under other Sections or Contracts are acceptable for metal fabrications installation in accordance with manufacturer's written instructions.
 - .1 Visually inspect substrate in presence of Departmental Representative.
 - .2 Inform Departmental Representative of unacceptable conditions immediately upon discovery.
 - .3 Proceed with installation only after unacceptable conditions have been remedied and after receipt of written approval to proceed from Departmental Representative.

3.2 ERECTION

- .1 Do welding work in accordance with CSA W59 unless specified otherwise.
- .2 Erect metalwork square, plumb, straight, and true, accurately fitted, with tight joints and intersections.
- .3 Provide suitable means of anchorage acceptable to Departmental Representative, such as dowels, anchor clips, bar anchors, expansion bolts and shields, and toggles.
- .4 Exposed fastening devices to match finish and be compatible with material through which they pass.
- .5 Supply components for work by other trades in accordance with shop drawings and schedule.
- .6 Make field connections with bolts to CSA S16 or Weld field connection as shown on drawings.
- .7 Deliver items over for casting into concrete and building into masonry together with setting templates to appropriate location and construction personnel.
- .8 Touch-up rivets, field welds, bolts and burnt or scratched surfaces with primer after completion of installation, using:
 - .1 Primer: maximum VOC limit 250 g/L to GS-11.

.9 Touch-up galvanized surfaces with zinc rich primer where burned by field welding, using:

.1 Primer: maximum VOC limit 250 g/L to GS-11.

3.3 GATE FRAMES

.1 Install new steel gate frames to Sallyport locations and to details indicated.

3.4 CLEANING

.1 Progress Cleaning: clean in accordance with Section 01 74 11 - Cleaning. Leave Work area clean at end of each day.

.2 Final Cleaning: upon completion remove surplus materials, rubbish, tools and equipment in accordance with Section 01 74 11 - Cleaning.

3.5 PROTECTION

.1 Protect installed products and components from damage during construction.

.2 Repair damage to adjacent materials caused by metal fabrications installation.

END OF SECTION

1. GENERAL

1.1 REFERENCES

- .1 Master Painters' Institute (MPI), Exterior Structural Steel and Metal Fabrication.
 - .1 EXT 5.1, Alkyd.
 - .2 EXT 5.1G, Zinc Rich/Aliphatic Polyurethane.
 - .3 EXT 5.4, Aluminum.
- .2 Steel Structures Painting Council (SSPC).
 - .1 SSPC-SP-6/NACE No. 3-00, Commercial Blast Cleaning.
 - .2 SSPC-SP-7/NACE No 4-00, Brush-off Blast Cleaning.
 - .3 SSPC Good Painting Practices, Volume 1, Latest Edition.

1.2 ACTION AND INFORMATIONAL SUBMITTALS

- .1 Manufacturer's Instructions: supply and apply paint to manufacturer's instructions.

1.3 QUALITY ASSURANCE

- .1 Pre-Construction Meeting: Discuss painting procedures to verify project requirements, manufacturer's installation instructions and manufacturer's warranty requirements for electrostatic painting of fence fabric as specified.

1.4 WASTE MANAGEMENT AND DISPOSAL

- .1 Separate and recycle waste materials in accordance with Section 01 74 21 – Construction Demolition.
- .2 Divert unused coating materials from landfill through disposal at a special wastes depot.

2. PRODUCTS

2.1 MATERIALS

- .1 Paint.
 - .1 Primer: MPI EXT 5.1C, primer, marine primer for steel.
 - .2 Enamel: MPI EXT 5.1G, enamel, alkyd, marine, exterior; first coat black colour. No second coat.
 - .3 Rust Conversion Paint for cable tray brackets.
- .2 Sand for sandblasting: to SSPC (Steel Structures Painting Council).

3. EXECUTION

3.1 MANUFACTURER'S INSTRUCTIONS

- .1 Compliance: comply with manufacturer's written data, including product technical bulletins, product catalogue installation instructions, product carton installation instructions, and data sheets.

3.2 SITE EXAMINATION

- .1 Precaution should be taken when removing loose and rusted existing paint from metal surfaces.

3.3 PREPARATION

- .1 New metal surfaces (new gate structure).
 - .1 Clean surfaces of new metal to be painted by removing rust, loose mill scale, welding slag, dirt, oil, grease and foreign substances in accordance with the following:
 - .1 Hand tool cleaning: SSPC-SP-2.
- .2 Metal surfaces to be repainted (fence fabric, fence posts, control arms).
 - .1 Clean surfaces by removing loose, cracked, brittle or non-adherent paint, rust, dirt, oil, grease and other foreign substances in accordance with following.
 - .1 Brush-off blast cleaning: SSPC-SP-7.
 - .2 Hand tool cleaning: SSPC-SP-2.
 - .3 Power tool cleaning: SSPC-SP-3.
 - .2 Commercial blast clean rusted and bare metal surfaces where existing galvanized fence fabric is rusted.
 - .3 Brush-off and blast clean remaining metal surfaces to be painted.
- .3 Cable tray brackets to be cleaned by sandblasting or wire brushing, and washed as recommended by paint manufacturer.
- .4 Compressed air to be free of water and oil before reaching nozzle.
- .5 Remove traces of blast products from surfaces, pockets and corners to be painted by brushing with clean brushes, by blowing with clean dry compressed air, or by vacuum cleaning.
- .6 Do not apply paint until prepared surfaces have been accepted by Departmental Representative.

- .7 Prior to commencing paint application the degree of cleanliness of surfaces to be in accordance with SSPC-Vis 1.
- .8 Protection of surfaces.
 - .1 Protect adjacent surfaces, features, components, etc. that are not to be painted and if damaged, clean and restore such surfaces as directed by Departmental Representative.
 - .2 Apply primer, paint, or pretreatment after surface has been cleaned and before deterioration of surface occurs.
 - .3 Clean surfaces again if rusting occurs after completion of surface preparation.
 - .4 Prevent contamination of cleaned surfaces by salts, acids, alkalis, corrosive chemicals, grease, oil and solvents before prime coat is applied and between applications of remaining coats of paint. Remove contaminants from surface and apply paint immediately.
 - .5 Protect cleaned and freshly painted surfaces from dust to approval of Departmental Representative.
- .9 Mixing paint.
 - .1 Do not dilute or thin paint for brush application; use as received from manufacturer.
 - .2 Mix ingredients in container before and during use and ensure breaking up of lumps, complete dispersion of settled pigment, and uniform composition.
 - .3 Do not mix or keep paint in suspension by means of air bubbling through paint.
 - .4 Thin paint for spraying according to manufacturer's instructions. If directions are not on container, obtain instructions in writing from manufacturer and provide copy of instructions to Departmental Representative.
- .10 Number of paint coats.
 - .1 New metal surfaces. (Metal fabrications)
 - .1 Shop: primer coat to minimum dry film thickness of 35 microns per coat.
 - .2 Field: One coat to minimum dry film thickness of 35 microns per coat.
 - .2 Repainting existing metal surfaces (Fence fabric).
 - .1 One coat to minimum dry film thickness of 35 microns to bare and sand blasted areas.
 - .3 Rust conversion paint to cable tray brackets: 1 coat.

3.4 APPLICATION

- .1 Apply paint by spraying, brushing, or combination of both. Use sheepskins or daubers when no other method is practical in places of difficult access.
- .2 Where surface to be painted is not protected / under cover, do not apply paint when:
 - .1 Air temperature is below 5 degrees C or when temperature is expected to drop to 0 degrees C before paint has dried.
 - .2 Temperature of surface is over 50 degrees C unless paint is specifically formulated for application at high temperatures.
 - .3 Fog or mist occurs at site; it is raining or snowing; there is danger of rain or snow; relative humidity is above 85%.
 - .4 Surface to be painted is wet, damp or frosted.
 - .5 Previous coat is not dry.
- .3 Provide cover when paint must be applied in damp or cold weather. Protect, shelter, or heat surface and surrounding air to comply with temperature and humidity conditions specified. Protect until paint is dry or until weather conditions are suitable.
- .4 Remove paint from areas which have been exposed to freezing, excess humidity, rain, snow or condensation. Prepare surface again and repaint.
- .5 Apply each coat of paint as continuous film of uniform thickness. Repaint thin spots or bare areas before next coat of paint is applied.
- .6 Brush application.
 - .1 Work paint into cracks, crevices and corners and paint surfaces not accessible to brushes by spray, daubers or sheepskins.
 - .2 Brush out runs and sags.
 - .3 Remove runs, sags and brush marks from finished work and repaint.
- .7 Spray application.
 - .1 Provide and maintain equipment that is suitable for intended purpose, capable of properly atomizing paint to be applied, and equipped with suitable pressure regulators and gauges.
 - .2 Provide traps or separators to remove oil and water from compressed air and drain periodically during operations.
 - .3 Keep paint ingredients properly mixed in spray pots or containers during paint application either by continuous mechanical agitation or by intermittent agitation as frequently as necessary.

- .4 Apply paint in uniform layer, with overlapping at edges of spray pattern.
- .5 Brush out immediately runs and sags.
- .6 Use brushes to work paint into cracks, crevices and places which are not adequately painted by spray. In areas not accessible to spray gun, use brushes, daubers or sheepskins.
- .7 Remove runs, sags and brush marks from finished work and repaint.
- .8 Shop painting.
 - .1 Do shop painting after fabrication and before damage to surface occurs from weather or other exposure.
 - .2 Spray paint contact surfaces of field assembled, bolted, friction type joints with primer coat only. Do not brush primer after spraying.
 - .3 Do not paint metal surfaces which are to be embedded in concrete.
 - .4 Do not paint metal within 50mm of edge to be welded. Give unprotected steel one coat of boiled linseed oil or other approved protective coating after shop fabrication is completed.
 - .5 Remove weld spatter before painting. Remove weld slag and flux by methods as specified.
- .9 Field painting.
 - .1 Paint steel structures as soon as practical after erection.
 - .2 Touch up metal which has been shop coated with same type of paint and to same thickness as shop coat. This touch-up to include cleaning and painting of field connections, welds, rivets, nuts, washers, bolts, and damaged or defective paint and rusted areas.
 - .3 Field paint surfaces (other than joint contact surfaces) which are accessible before erection but which are not to be accessible after erection.
 - .4 Do not apply final coat of paint until concrete work is completed, except as directed by Departmental Representative. If concreting or other operations damage paint, clean and repaint damaged area. Remove concrete spatter and droppings before paint is applied.
 - .5 Where painting does not meet with requirements of specifications, and when so directed by Departmental Representative remove defective paint, thoroughly clean affected surfaces and repaint in accordance with these specifications.
- .10 Handling painted metal.
 - .1 Do not handle painted metal until paint has dried, except for necessary handling for painting or stacking for drying.

- .2 Scrape off and touch up paint which is damaged in handling, with same number of coats and kinds of paint as were previously applied to metal.

3.5 FIELD QUALITY CONTROL

- .1 Site Tests, Inspections.
 - .1 Upon completion of the painting procedures test for dry film reading and evaluate the results as per SSPC PA 2.

3.6 CLEANING

- .1 Upon completion of installation, remove surplus materials, rubbish, tools and equipment in accordance with Section 01 74 11 - Cleaning.

END OF SECTION

1. GENERAL

1.1 REFERENCES

- .1 American Society for Testing and Materials International (ASTM)
 - .1 ASTM C 117-04, Standard Test Method for Material Finer than 0.075 mm (No.200) Sieve in Mineral Aggregates by Washing.
 - .2 ASTM C 136-05, Standard Test Method for Sieve Analysis of Fine and Coarse Aggregates.
 - .3 ASTM D 422-63(2002), Standard Test Method for Particle-Size Analysis of Soils.
 - .4 ASTM D 698-00ae1, Standard Test Methods for Laboratory Compaction Characteristics of Soil Using Standard Effort (12,400 ft-lbf/ft³) (600 kN-m/m³).
 - .5 ASTM D 1557-02e1, Standard Test Methods for Laboratory Compaction Characteristics of Soil Using Modified Effort (56,000 ft-lbf/ft³) (2,700 kN-m/m³).
 - .6 ASTM D 4318-05, Standard Test Methods for Liquid Limit, Plastic Limit, and Plasticity Index of Soils.
- .2 Canadian General Standards Board (CGSB)
 - .1 CAN/CGSB-8.2-M88, Sieves, Testing, Woven Wire, Metric.
- .3 Canadian Standards Association (CSA International)
 - .1 CSA-A23.1/A23.2-09, Concrete Materials and Methods of Concrete Construction/Methods of Test and Standard Practices for Concrete.

1.2 DEFINITIONS

- .1 Excavation classes: two classes of excavation will be recognized; common excavation and rock excavation. Excavation costs are incidental to unit price items and costs for excavation should be included in those items' unit price.
 - .1 Rock excavation: any solid material in excess of 0.50 m³ and which cannot be removed by means of heavy duty mechanical excavating equipment with 0.95 to 1.15 m³ bucket. Frozen material will not be classified as rock.
 - .2 Common excavation: excavation of materials of whatever nature, which are not included under definitions of rock excavation.
- .2 Unclassified excavation: excavation of deposits of whatever character encountered in Work.
- .3 Topsoil:

- .1 Material capable of supporting good vegetative growth and suitable for use in top dressing, landscaping and seeding.
- .4 Waste material: excavated material unsuitable for use in Work or surplus to requirements.
- .5 Borrow material: material obtained from locations outside area to be graded, and required for construction of fill areas or for other portions of Work.
- .6 Unsuitable materials:
 - .1 Weak, chemically unstable, and compressible materials.
 - .2 Frost susceptible materials:
 - .1 Fine grained soils with plasticity index less than 10 when tested to ASTM D 4318-05, and gradation within limits specified when tested to ASTM D 422-63 (2002) and ASTM C 136-05: Sieve sizes to CAN/CGSB-8.2.
 - .2 Table:

Sieve Designation	% Passing
2.00 mm	100
0.10 mm	45 - 100
0.02 mm	10 - 80
0.005 mm	0 - 45
 - .3 Coarse grained soils containing more than 20% by mass passing 0.075 mm sieve.
- .7 Unshrinkable fill: very weak mixture of cement, concrete aggregates and water that resists settlement when placed in utility trenches, and capable of being readily excavated.
- .8 Anti-Tunnel Mix: 50/50 sand/cement mix tilled into soil, width/depth as indicated on drawings, continuous along perimeter of construction fence.

1.3 ACTION AND INFORMATIONAL SUBMITTALS

- .1 Samples:
 - .1 Submit samples in accordance with Section 01 33 10 - Submittal Procedures.
 - .2 Inform Consultant at least 1 week prior to beginning Work, of proposed source of fill materials and provide access for sampling.

1.4 PROTECTION OF EXISTING FEATURES

- .1 Existing buried utilities and structures:
 - .1 Size, depth and location of existing utilities and structures as indicated are for guidance only. Completeness and accuracy are not guaranteed

- .2 Prior to commencing excavation work, notify applicable owner or authorities having jurisdiction, establish location and state of use of buried utilities and structures. Contractor's hired Locator Company to clearly mark such locations to prevent disturbance during work.
- .3 Confirm locations of buried utilities by careful test excavation.
- .4 Maintain and protect for damage, water, sewer, gas, electric, telephone and other utilities and any structures encountered as may be indicated on drawings.
- .5 Where utility lines or structures exist in area of excavation, obtain direction of Departmental Representative before removing or re-routing.
- .6 Record location of maintained, re-routed and abandoned underground lines.

2. PRODUCTS

2.1 MATERIALS

- .1 Fill properties to meet the following properties:
 - .1 Crushed, pit run or screened stone, gravel or sand.
 - .2 Gradations to be within limits specified when tested to ASTM C 136 and ASTM C 117. Sieve sizes to CAN/CGSB-8.2.
 - .3 Durability requirement: max 40% loss in the LA Abrasion test – ASTM C131 or C535.

Sieve Designation	% Passing	
	Type 1	Type 2
80 mm	-	100
40 mm	-	-
25 mm	-	60 - 84
20 mm	100	35 - 69
12.5 mm	40 - 80	-
10 mm	20 - 62	25 - 54
5.00 mm	0 - 20	17 - 34
2.36 mm	0 - 10	12 - 35
1.25 mm	-	8 - 28
0.315 mm	-	4 - 16
0.080 mm	0 - 3	0 - 7

- .2 Type 3 fill: selected material from excavation or other sources, approved by Consultant for use intended, unfrozen and free from rocks larger than 75 mm, cinders, ashes, sods, refuse or other deleterious materials

3. EXECUTION

3.1 SITE PREPARATION

- .1 Remove obstructions, ice and snow, from surfaces to be excavated within limits indicated.
- .2 Install temporary backfill material in areas required to accommodate access to the building.

3.2 STRIPPING OF TOPSOIL

- .1 Begin topsoil stripping of areas as indicated after area has been cleared of brush, weeds and grasses and removed from site.
- .2 Strip topsoil to depths as indicated. Do not mix topsoil with subsoil.
- .3 Stockpile in locations as directed by Departmental Representative.
- .4 Stockpile height not to exceed 2 m and should be protected from erosion.
- .5 Dispose of unused topsoil to location as directed by Departmental Representative.

3.3 DEWATERING AND HEAVE PREVENTION

- .1 Keep excavations free of water while Work is in progress.
- .2 Protect open excavations against flooding and damage due to surface run-off.

3.4 EXCAVATION

- .1 Excavate to lines, grades, elevations and dimensions as indicated.
- .2 Excavation must not interfere with normal 45° splay of bearing from bottom of any foundation.
- .3 Dispose of surplus and unsuitable excavated material off site.
- .4 Do not obstruct flow of surface drainage or natural watercourses.
- .5 Earth bottoms of excavations to be undisturbed soil, level, free from loose, soft or organic matter.
- .6 Remove unsuitable material from trench bottom including those that extend below required elevations to extent and depth as necessary.
- .7 Correct unauthorized over-excavation as follows:
 - .1 Fill under bearing surfaces and footings with concrete specified for footings.
 - .2 Fill under other areas with Type 2 fill compacted to not less than 98% of corrected maximum dry density.

- .8 Hand trim, make firm and remove loose material and debris from excavations.
 - .1 Where material at bottom of excavation is disturbed, compact foundation soil to density at least equal to undisturbed soil.
 - .2 Clean out rock seams and fill with concrete mortar or grout to approval of Consultant.

3.5 FILL TYPES AND COMPACTION

- .1 Use types of fill as indicated or specified below. Compaction densities are percentages of maximum densities obtained from ASTM D 698.
 - .1 Curbs, gutters and walks: Use Type 3 fill to thickness as indicated on drawings. Compact to 95%.

3.6 BACKFILLING

- .1 Vibratory compaction equipment: suitable to produce the compaction densities as specified.
- .2 Do not proceed with backfilling operations until the Consultant has inspected and approved installations.
- .3 Areas to be backfilled to be free from debris, snow, ice, water and frozen ground.
- .4 Do not use backfill material which is frozen or contains ice, snow or debris.
- .5 Place backfill material in uniform layers not exceeding 150 mm compacted thickness up to grades indicated. Compact each layer before placing succeeding layer.

3.7 RESTORATION

- .1 Upon completion of Work, remove waste materials and debris in accordance to Section 01 74 21 – Construction Demolition, trim slopes, and correct defects as directed by Consultant.
- .2 Reinstate pavements and sidewalks lawns disturbed by excavation to thickness, structure and elevation which existed before excavation.
- .3 Clean and reinstate areas affected by Work as directed by Departmental Representative.

END OF SECTION

1. GENERAL

1.1 REFERENCES

- .1 American Society for Testing and Materials International, (ASTM).
 - .1 ASTM A 53/A 53M-02, Standard Specification for Pipe, Steel, Black and Hot-Dipped, Zinc-Coated Welded and Seamless.
 - .2 ASTM A 90/A 90M-01, Standard Test Method for Weight of Coating on Iron and Steel Articles with Zinc or Zinc-Alloy Coatings.
 - .3 ASTM A 121-99, Standard Specification for Zinc-Coated (Galvanized) Steel Barbed Wire.
 - .4 A653/A653M-03, Standard Specification for Steel Sheet, Zinc-Coated (Galvanized) or Zinc-Iron Alloy-Coated (Galvannealed) by the Hot-Dip Process.
 - .5 ASTM A 585-97, Specification for Aluminum Coated Steel Barbed Wire.
 - .6 ASTM F 1664-01, Standard Specification for Polyvinyl Chloride (PVC) - Coated Steel Tension Wire Used with Chain Link Fence.
- .2 Canadian General Standards Board (CGSB).
 - .1 CAN/CGSB-138.1-96, Fabric for Chain Link Fence.
 - .2 CAN/CGSB-138.2-96, Steel Framework for Chain Link Fence.
 - .3 CAN/CGSB-138.3-96, Installation of Chain Link Fence.
 - .4 CAN/CGSB-138.4-9, Gates for Chain Link Fence.
 - .5 CAN/CGSB-1.181-99, Ready-Mixed Organic Zinc-Rich Coating.
- .3 Canadian Standards Association (CSA International).
 - .1 CAN/CSA-A23.1/A23.2-09 (August 2001), Concrete Materials and Methods of Concrete Construction / Methods of Test for Concrete.
 - .2 CAN/CSA-G164-M92 (R2003), Hot Dip Galvanizing of Irregularly Shaped Articles.
 - .3 CAN/CSA-A3000-98 (R2002), Cementitious Materials Compendium.
 - .4 CAN/CSA-A23.5-98, Supplementary Cementing Materials

1.2 SUBMITTALS

- .1 Submittals in accordance with Section 01 33 10 - Submittal Procedures.

2. PRODUCTS

2.1 MATERIALS

- .1 Materials are to be supplied to meet requirements of CSC Technical Criteria, March 2014.
- .2 Chain-link fence fabric: to CAN/CGSB-138.1.
 - .1 Type 1, Class B, 6 gauge.
 - .2 Height of fabric: 3600 mm, or as noted on drawings.
 - .3 Mesh size: 50 x 50 mm.
 - .4 Selvage: bottom knuckled, top twisted.
- .3 Posts, braces and rails: to CAN/CGSB-138.2, galvanized steel pipe. Dimensions as indicated.
 - .1 Line posts: 73 mm, Schedule 40 tubular steel pipe, scale free, hot dipped galvanized.
 - .2 Terminal posts and Gate posts: 150 mm, Schedule 40 tubular steel pipe, scale free, hot dipped galvanized.
 - .3 Top rail: 43 mm Schedule, 40 tubular steel pipe, scale free, hot dipped galvanized.
 - .4 Braces at corner, straining and end posts: 150 mm, Schedule 40 tubular steel pipe, scale free, hot dipped galvanized.
- .4 Bottom rail: 43 mm, schedule 40 tubular steel pipe, scale free, hot dipped galvanized.
- .5 Tie wire fasteners: single strand, galvanized steel wire conforming to requirements of fence fabric, 3.7 mm diameter. (Wire to conform to Institution requirements "military tie").
- .6 Tension bar: to ASTM A 653/A 653M, 5 x 19 mm minimum galvanized steel.
- .7 Tension bar bands: 3 x 19 mm minimum galvanized steel.
- .8 Gates: to CAN/CGSB-138.4.
- .9 Gate frames: to ASTM A 53/A 53M, galvanized steel pipe, standard weight 76 mm outside diameter pipe for outside frame, 76 mm outside diameter pipe for interior bracing. Fabricate new gates to match existing, or as follows:
 - .1 Fabricate gates as indicated with electrically welded joints, and hot-dip galvanized after welding.
 - .2 Fasten fence fabric to gate with twisted selvage at top.

- .3 Furnish gates with galvanized malleable iron ball bearing roller wheels, minimum 1 per gate, 200 mm in diameter, gate hinges, and lock and latch catch with provision for padlock which can be attached and operated from either side of installed gate.
- .4 Furnish double gates with chain hook to hold gates open and centre rest with drop bolt for closed position.
- .10 Fittings and hardware: to CAN/CGSB-138.2, cast aluminum alloy, galvanized steel or malleable or ductile cast iron.
 - .1 Post caps to provide waterproof fit, to fasten securely over posts and to carry top rail.
 - .2 Replace broken post caps and missing caps when discovered during the course of fence repairs.
 - .3 Turnbuckles to be drop forged.
 - .4 Control arms to be galvanized steel angled at 45° towards the institution side.
- .11 Organic zinc rich coating: to CAN/CGSB-1.181-92.
- .12 Fence supplier to provide and install new barbed wire and Concertina wire where indicated on drawings and specifications.
- .13 Not used.
- .14 Concertina Wire description:
 - .1 Galvanized tape 20 x 0.5 mm clenched around a 2.5 mm dia. spring steel galvanized core wire to form a concertina coil with a nominal exterior coiled diameter of 710 mm.
 - .2 Concertina to be formed by clipping adjacent loops of single helical coils together at a minimum of three points on the circumference. Clips to be galvanized.
 - .3 Loop spacing shall not exceed 230 mm.
 - .4 For concertina coil support at fence top, two barbed wires stretched and fixed to post control arms shall be provided. Barbed wire shall consist of two strands of 12 gauge wire with 4-point barbs at 130 mm spacing, all galvanized.
- .15 Installation of Concertina coils:
 - .1 Concertina wire is to be supported and tied at 230 mm spacing onto each strand of barbed wire.
 - .2 A second Concertina coil will be installed on the inner perimeter fence where indicated. This coil will not interfere with the fence detection system.

- .16 Return Concertina wire onto secondary interior fences for a distance of 2.5 meters when such secondary fence intersects with the perimeter fence.
- .17 Concertina will not be painted.

2.2 FINISHES

- .1 Galvanizing:
 - .1 For chain link fabric: to CAN/CGSB-138.1-96 Grade 2.
 - .2 For pipe: 600 g/m² minimum to ASTM A90/A90M-01.
 - .3 For other fittings: to CAN/CSA-G164.
- .2 Sandblasting: (See also Section 09 97 19)
 - .1 Sandblast existing fence fabric to extent indicated on the drawings, Commercial blast.
 - .2 Protect adjacent surfaces that are not to be sandblasted or painted.
 - .3 Collect sandblasting material for reuse or disposal.
 - .4 Sandblasting contractor to leave the fence surfaces and adjacent areas clean and ready for painting contractor.
- .3 Electrostatic painting: (See also Section 09 97 19)
 - .1 Painting contractor to verify and accept results of sandblasting and condition of metals to be repainted, prior to proceeding with painting tasks.
 - .2 Painting contractor to protect from paint overspray adjacent surfaces and structures that are not to be painted.
 - .3 Painting contractor to paint fence components only when ambient temperatures, humidity levels, wind conditions, etc. is at an acceptable level to ensure full paint coverage to required thickness and to ensure full curing. Conform to paint supplier recommendations.

3. EXECUTION

3.1 GRADING

- .1 Remove debris and correct ground undulations along fence line to obtain smooth uniform gradient between posts.
- .2 Maintain clearance between bottom of fence and ground surface to a maximum of 30 mm.

3.2 ERECTION OF FENCE

- .1 Erect fence along lines as indicated on drawings, and to CAN/CGSB-138.3.
- .2 Excavate holes at fence locations for posts, as indicated on drawings.
- .3 Space line posts maximum 2.5 m apart or as otherwise stated on drawings, measured parallel to the ground surface.
- .4 Space straining posts at equal intervals not to exceed 150 m if distance between end or corner posts on straight continuous lengths of fence over reasonably smooth grade, is greater than 150 m.
- .5 Install terminal/end posts at end of fence and at buildings. Install gate posts on both sides of gate openings to provide required clear opening width.
- .6 Place concrete in post holes then embed posts into concrete to minimum 1650 mm depth.
 - .1 Posts to be set plumb and within 6mm from centre of footing/pile.
 - .2 Extend concrete 50 mm above ground level and slope top to drain away from posts.
 - .3 Brace steel posts in plumb position and true to alignment and elevation until concrete has set.
- .7 Do not install fence fabric until concrete has cured minimum of 3 days.
- .8 Provide temporary security measures for the duration of the cure times, conforming to institutional requirements, as directed by the Departmental Representative.
- .9 Install top and bottom rail between posts and fasten securely to posts.
- .10 Lay out fence fabric. Stretch tightly to tension recommended by manufacturer and fasten to end, corner, gate and straining posts with tension bar secured to post with tension bar bands spaced at 300 mm intervals. Employ CSC test per Technical Criteria.
 - .1 Knuckled selvedge at bottom.
 - .2 Twisted selvedge at top.
- .11 Secure fabric to top rails, line posts and bottom tension wire with galvanized steel tie wires at 300 mm intervals. Conform to institution standards. Give tie wires minimum two twists.
- .12 Install angled bracket at top of fence post complete with barbed Concertina wire as specified.

3.3 INSTALLATION OF GATES

- .1 Install gates in locations as indicated or as directed by Departmental Representative.

- .2 Level ground between gate posts and set gate bottom approximately 40 mm above ground surface.
- .3 Determine position of centre gate rest for double gate.
 - .1 Cast gate rest in concrete as directed.
 - .2 Dome concrete above ground level to shed water.
- .4 Install gate stops where indicated or as required to prevent damage to fence or adjacent structures.
- .5 Install steel concertina wire along top of fence c/w two strands of barbed wire, and fasten to purpose made bracket fastened to each upright, as shown. See drawings for details.
- .6 Gate Operation: the new gate operators shall include a hand crank for manual operation of gates in case of power outage, maintenance / repair, or emergency.
- .7 Chain Replacement: See drawings for chain replacement for gates. Contractor shall coordinate and supervise the chain replacement of the gate operators.
- .8 The contractor will coordinate with the Departmental Representative the shutdown of the gates and gate operators, and will provide for manual gate operation during chain replacement, as required by the Departmental Representative.

3.4 TOUCH UP

- .1 Clean damaged surfaces with wire brush removing loose and cracked coatings. Apply two coats of organic zinc-rich paint to damaged areas as per manufacturers' recommendation. Pre-treat damaged surfaces according to manufacturers' instructions for zinc-rich paint.

3.5 CLEANING

- .1 Clean and trim adjacent landscaped, graveled or asphalt paved areas disturbed by operations to original conditions.

END OF SECTION

APPENDIX A

CSC Technical Criteria



Correctional Service
Canada

Service correctionnel
Canada



SAFETY, RESPECT
AND DIGNITY
FOR ALL

LA SÉCURITÉ,
LA DIGNITÉ
ET LE RESPECT
POUR TOUS

Technical Criteria Correctional Institutions

SECTION SP - SITE

TABLE OF CONTENTS
SP-1 SITE - SITE PLANNING AND DEVELOPMENT

1.	SCOPE	4
2.	RELATED SECTIONS.....	4
3.	INSTITUTIONAL PROPERTY	4
4.	RESERVE OF OPEN LAND	4
5.	NO MAN ZONE.....	4
6.	BUFFER ZONE.....	5
7.	NO BUILDING ZONE	5
8.	NO INMATE ZONE.....	5
9.	SITE PLANNING AND DEVELOPMENT OF AN INSTITUTION	5
10.	SIGNAGE	6
11.	ENVIRONMENTAL.....	7
12.	PLAYFIELD AND YARDS	7
13.	FLAG AND FLAGPOST.....	8

SP-2 SITE - FENCE

1.	SCOPE	13
2.	RELATED SECTIONS.....	13
3.	EXTERNAL BOUNDARY FENCES	13
4.	PERIMETER SECURITY FENCES.....	13
5.	INTERIOR FENCES	17
6.	SEPARATION OF DISTINCT POPULATIONS IN ONE INSTITUTION (MULTI-LEVEL).....	17
7.	EXTERIOR SERVICE COMPOUND FENCE	18

SP-3 SITE - GATES/SALLYPORT

1.	SCOPE	25
2.	RELATED SECTIONS.....	25
3.	ACCESS CONTROL SECURITY REQUIREMENTS.....	25
4.	PRINCIPAL ENTRANCE.....	26
5.	FENCE GATES	27

TABLE OF CONTENTS

SP-4 SITE - EXTERIOR LIGHTING

1. SCOPE 36

2. RELATED SECTIONS..... 36

3. GENERAL REQUIREMENTS..... 36

4. APPLICATIONS 37

5. PERFORMANCE REQUIREMENTS..... 37

SP-5 SITE - TRAFFIC CIRCULATION AND PARKING

1. SCOPE 53

2. RELATED SECTIONS..... 53

3. CIRCULATION SECURITY REQUIREMENTS 53

4. DESIGN REQUIREMENTS..... 54

SP-6 SITE - TEMPORARY CONSTRUCTION FENCES

1. SCOPE AND DEFINITIONS 58

2. RELATED SECTIONS..... 58

3. PERFORMANCE CRITERIA 59

4. RELEVANT SPECIFICATIONS..... 60

SP-1 SITE – SITE PLANNING AND DEVELOPMENT

1. SCOPE

This section outlines planning and development principles and specific definitions of terms related to detention institutions.

2. RELATED SECTIONS

SP-2 – Fences

SP-3 – Institutional Access Controls

SP-4 – Lighting

SP-5 – Traffic Circulation and Parking

3. INSTITUTIONAL PROPERTY

There is no specific requirement regarding a demarcation or fencing at the CSC owned property line. Signage at the property limit is recommended. Where signage is used, it shall follow the Federal Identity Program¹.

Property features such as topographical conditions and existing trees and bushes shall be used to screen CSC institutions from adjoining properties. Landscaping and site development along the main entry road shall be visually appealing.

Where more than one institution is located on a CSC property, sufficient space shall be allowed between institutions. Minimum security institutions shall be located furthest from that part of a medium or maximum institution where inmate circulation and activities take place.

4. RESERVE OF OPEN LAND

4.1 Where possible and with minimal alterations to natural land and its ecology, a reserve of open land shall be provided for a distance of 100 m from the exterior of the outer perimeter fence to facilitate views of an intruder or escapee. Where natural grade changes exist, these shall be retained. Where open land reserves are smaller than the 100 m due to prohibitive site conditions or limiting extent of crown land, additional security measures may be required, as determined on a project specific basis

4.2 Landscaping for the first 100 m within the open land reserve shall consist of grasses, trees and shrubs which minimize the potential for screening an intruder or an escapee.

4.3 Due to specific operational requirements, the reserve of open land can extend over structures such as CSC service buildings, parking lots, flag posts and light standards, and site enhancements. These elements should be located close to the main entrance to the institution and away from inmate outdoor circulation and activity areas in order to limit the potential for contraband transfer over the institutional perimeter.

5. NO MAN ZONE

5.1 This zone is the ground area between the outer perimeter fence and the inner perimeter fence. The distance between the perimeter fences is 7.5 m.

¹ 4.3 – Common-use and operational signs, Federal Identity Program Manual, March 1990
http://www.tbs-sct.gc.ca/fip-pcim/man_4_3-eng.asp

- 5.2** The no man zone ground surface shall have the top soil removed and covered with filter fabric and crushed stone for a depth of at least 200 mm to minimize plant growth.
- 5.3** This zone is equipped with an in-ground sensor to detect motion. It is a component of the Perimeter Intrusion Detection System (PIDS), referred to as the Motion Detection System (MDS). To minimize false alarms activated by the MDS, the ground surface between the fences shall be graded to prevent pooling of water and run-off shall be collected as described in section SU-1, Storm and Sanitary Sewers.
- 5.4** This zone is covered by camera surveillance. The cameras will focus on the section of the fence line which has been disturbed. Cameras are an integrated part of the PIDS.

6. BUFFER ZONE

- 6.1** A 4-meter buffer zone parallel to the interior side of the inner perimeter fence shall be free of all structures, trees, shrubs and roads, except for road access through the perimeter and connecting interior fences where required.
- 6.2** Where adjacent to playfields, ceremonial grounds, and gardens, this zone shall be marked by signage informing inmates not to trespass. Fencing shall not be used to demarcate this zone as it only serves to obstruct views from the mobile patrols on the outside of the perimeter. As well, the fence may capture balls which may only encourage retrieval resulting in enforcement and imposition of charges.
- 6.3** The buffer zone is covered by a separate line of cameras from those used to cover the no man zone. Similar to the no man zone, the cameras will focus on the section of the buffer zone in which the fence has been disturbed.

7. NO BUILDING ZONE

- 7.1** With the exception of the Gatehouse, no building shall be closer than 12 m to the inner perimeter fence.

8. NO INMATE ZONE

- 8.1** This is the area along the perimeter fence which is close to the Gatehouse and functions receiving vehicles. Access to inmates here is generally restricted or highly controlled. There is no specific distance to delimit this zone as it varies depending on the plan configuration.
- 8.2** Functions allowing controlled access to inmates within this zone include Visits and Private family visits, both shared with outside visitors.

9. SITE PLANNING AND DEVELOPMENT OF AN INSTITUTION

- 9.1** Institutional buildings closest to the gatehouse shall accommodate functions which are inaccessible to inmates or where access is supervised. Those functions requiring vehicle access for servicing and supplies shall also be relatively close to the gatehouse while vehicle access routes shall be away from inmate circulation and activity areas. Housing areas, playfields, gardens, and ceremonial grounds shall be located furthest from the entrance.

- 9.2** Soft landscaping is encouraged but plant type should be selected based on not obstructing views. Gentle contouring is also acceptable as are earth berms and timber retaining walls provided they do not facilitate hiding.
- 9.3** Colour and visual relief can be achieved in this area by the use of flowers beds, which shall be planted and maintained by inmates.
- 9.4** At medium level and above, all site furniture shall be secured in place. All walking surfaces shall be of monolithic material; small and light paving materials (brick, concrete pavers, or gravel) shall not be used.
- 9.5** Positive drainage for the entire site shall be provided with the use of ditches, swales and flumes. All drainage areas shall be designed to be as shallow as possible to allow for easier maintenance and for unobstructed visibility.
- 9.6** The minimum grade slope shall be 3% or gradual slope where natural grade changes exist for grass and landscaped areas.

10. SIGNAGE

- 10.1** All exterior and interior building signage shall conform to the Federal Identity Program (FIP). The FIP Manual is fully available at:

<http://www.tbs-sct.gc.ca/fip-pcim/>

- 10.2** The CSC “Search Sign” shall be located at each public entry leading to an institution. The “Search Sign” is a warning sign as prescribed in the Federal Identity Program Manual² (Caution!, Attention! under Type 3). The standard is yellow background with black letters. For the purpose of a reading distance of 30 m and a vehicular speed of 30 km/h, “x” is defined as 50 mm. Therefore, the text letters size is 50 mm (x) and the header letters size is 150 mm (3x). The layout is provided in Table 5 – Standard spaces, 50 mm to 200 mm x-height of section 4.3 of the FIP Manual (see footnote 8). The bilingual text is side by side, the official language on the left side being according to the regional practice. As the font and design follows the Federal Government standards the use of the Department signature or CSC crest is optional.

<p>Attention!</p> <p>You are now entering a Correctional Service Canada reserve and all vehicles and persons on this reserve are subject to search.</p>	<p>Attention!</p> <p>Vous pénétrez présentement sur une réserve du Service Correctionnel Canada et tout véhicule et personne sur cette réserve sont sujets à être fouillés.</p>
--	--

OR

² Federal Identity Program Manual – 4.3 Common-use and operational signs, Treasury Board of Canada, Secretariat, March 1990; http://www.tbs-sct.gc.ca/fip-pcim/documents/man_4_3_p1.pdf and http://www.tbs-sct.gc.ca/fip-pcim/documents/man_4_3_p2.pdf
Federal Identity Program Manual – 4.5 Signage typeface, Treasury Board of Canada, January 1988; http://www.tbs-sct.gc.ca/fip-pcim/documents/man_4_5.pdf

<h2 style="margin: 0;">Attention!</h2> <p style="margin: 0;">Vous pénétrez présentement sur une réserve du Service Correctionnel Canada et tout véhicule et personne sur cette réserve sont sujets à être fouillés.</p>	<h2 style="margin: 0;">Attention!</h2> <p style="margin: 0;">You are now entering a Correctional Service Canada reserve and all vehicles and persons on this reserve are subject to search.</p>
---	---

Refer to *CAN/CGSB-109.1M-1989*³ for the sign structure and characteristics.

- 10.3** All areas restricted only to authorized personnel shall be clearly and boldly identified according to the common-use and operational signs as described in the Federal Identity Program Manual⁴. Refer to section A-9 Interior Signage for interior signage requirements.

11. ENVIRONMENTAL

- 11.1** Only indigenous plants and locally available materials shall be used.
- 11.2** All layouts and landscape material shall take into account snow removal, grass cutting, watering and tree and shrub trimming to ensure minimum watering.
- 11.3** Snow storage areas shall be located in a manner that does not restrict drainage and visibility. A space wide enough to accommodate tractor power mowers shall be provided between trees and planting beds. Hose bibs shall be provided throughout the site as required on a project specific basis. Underground watering pipes or hoses shall not be used.

12. PLAYFIELDS AND YARDS

Playfields, which often have a high concentration of inmates, generally have their outer bounds located adjacent to the perimeter fence. For new installations, playfields shall be located within an interior courtyard bounded by housing units. Playfields in either location shall be distant from the Gatehouse, buildings located on the exterior, and parking lots in order not to offer opportunities to covertly approach the perimeter fence line and throw over contraband in proximity of the playfield. Playfields shall also be located distant from Segregation units and yards and Health Care.

Playfields are typically grassed except where the activity calls for a hard surface. Fine gravel or a monolithic hard surface such as asphalt is acceptable.

Small fenced yards associated with Segregation or special population units are asphalted to allow use in all weather, to prevent hiding of contraband, and to facilitate maintenance. The asphalt surface shall extend beyond the containment fence by 900mm.

³ CAN/CGSB-109.1M-1989 – Signage System, Extruded Aluminum, Federal Identity Program

⁴ Page 11 – Federal Identity Program Manual – 4.3 Common-use and operational signs, Treasury Board of Canada, Secretariat, March 1990; http://www.tbs-sct.gc.ca/fip-pcim/documents/man_4_3_p1.pdf

13. FLAG AND FLAGPOST

Rules and protocol for “flying the flag” are fully available at:

<http://www.pch.gc.ca/pgm/ceem-cced/etiqt/101-eng.cfm>

Refer to *CAN/CGSB-98.1-2003*⁵ for the outdoor use of the National Flag of Canada.

⁵ CAN/CGSB-98.1-20011 – National Flag of Canada (Outdoor Use) ICS 99.020.10

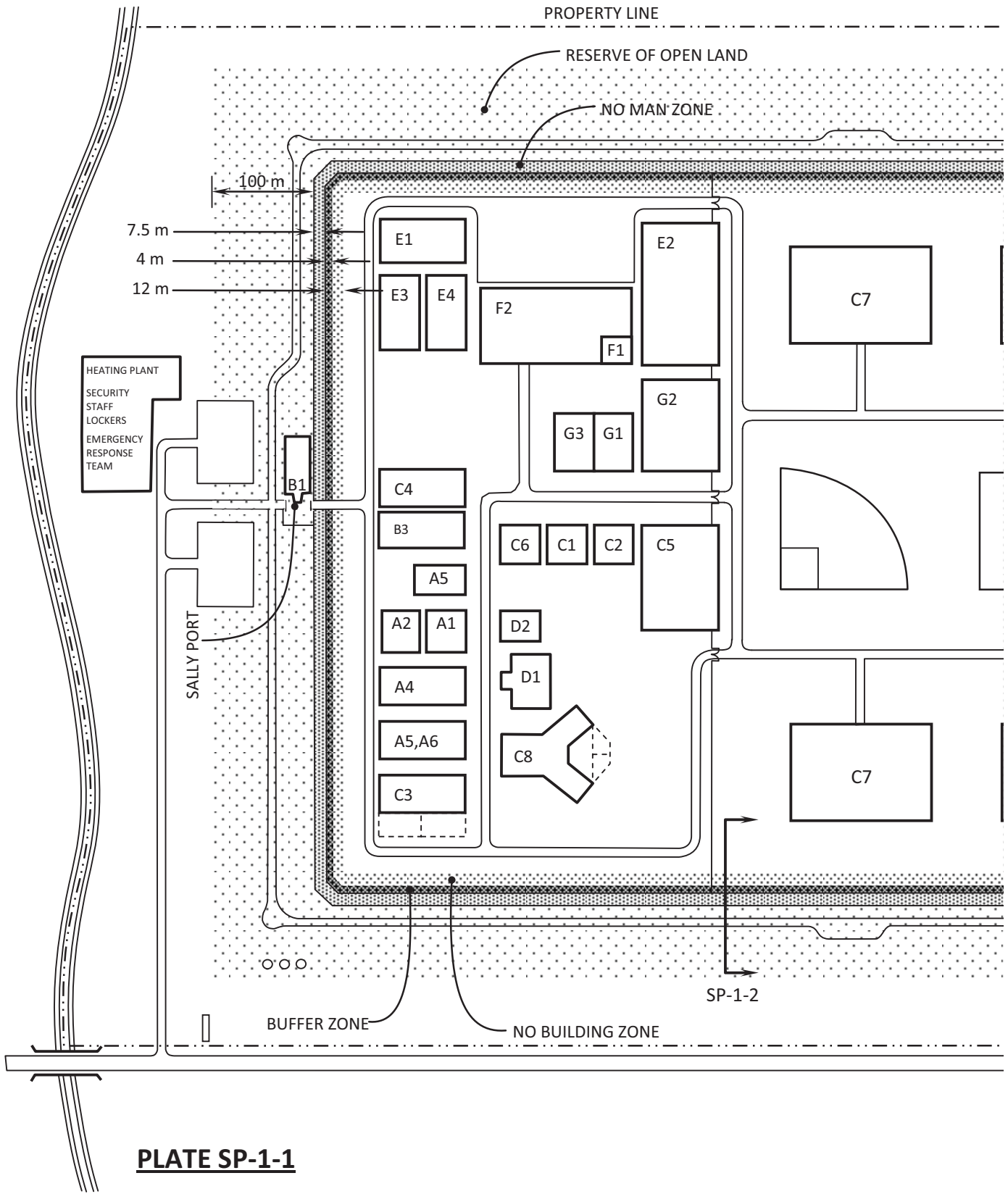
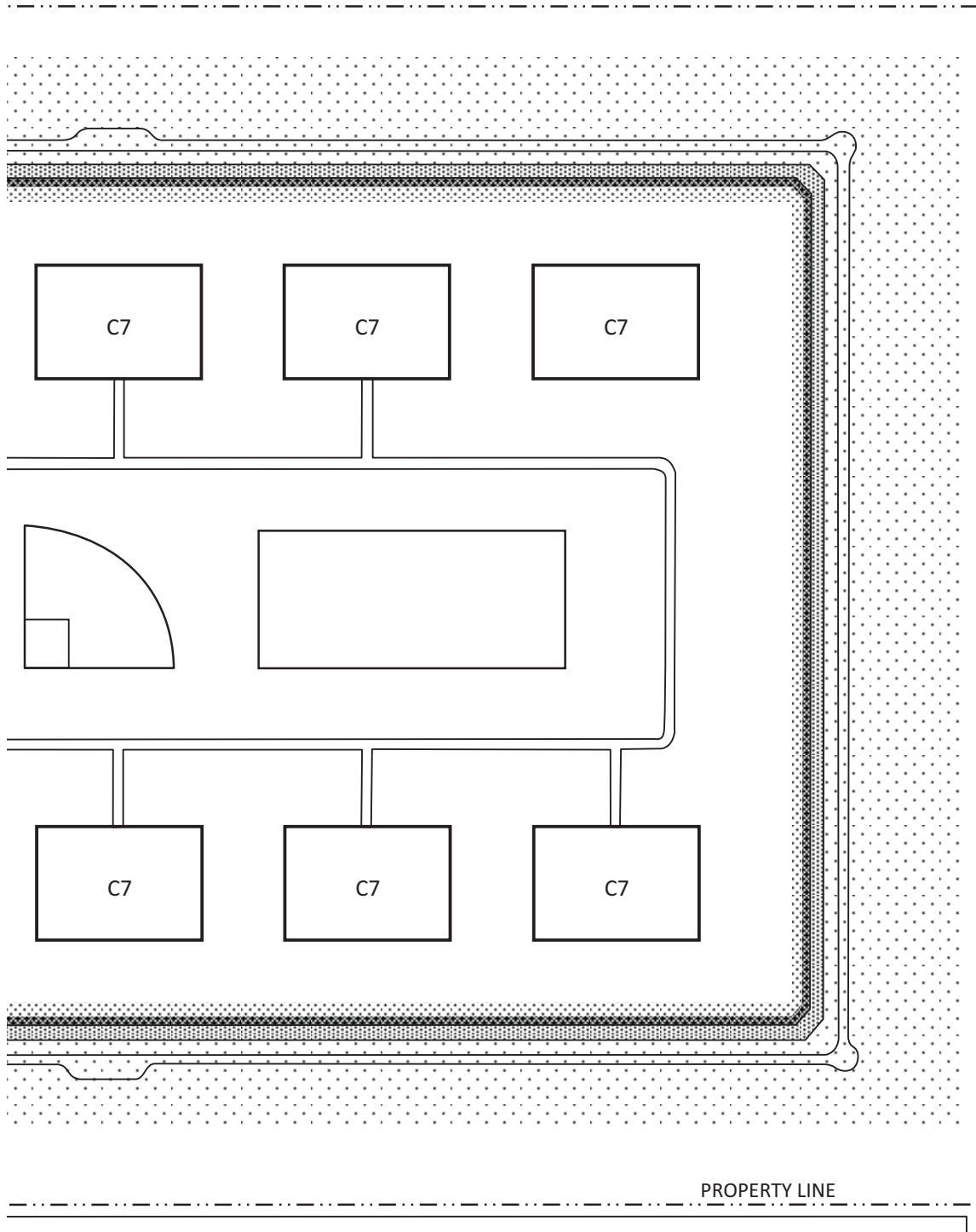

PLATE SP-1-1



BLE A-1-1 – ORGANIZATION OF DEPARTMENTS**GROUP A – ADMINISTRATION**

- A1 MANAGEMENT CENTRE
- A2 FINANCE
- A3 STAFF SERVICES AND TRAINING
- A4 ADMINISTRATION AND PERSONNEL
- A5 CASE AND SENTENCE ADMINISTRATION
- A6 NATIONAL PAROLE BOARD HEARING

GROUP B – SECURITY

- B1 EXTERNAL CONTROL (GATEHOUSE)
- B2 INTERNAL CONTROL
- B3 SECURITY ADMINISTRATION
- B4 ADMISSIONS AND DISCHARGE

GROUP C – SOCIALIZATION

- C1 SOCIAL AND CULTURAL DEVELOPMENT
- C2 ARTS AND CRAFTS
- C3 PRIVATE FAMILY VISITING
- C4 VISITS AND CORRESPONDENCE
- C5 RECREATION
- C6 CHAPLAINCY
- C7 INMATE HOUSING
- C8 SEGREGATION

GROUP D – HEALTH CARE

- D1 HEALTH CARE CENTRE
- D2 MENTAL HEALTH

GROUP E – TECHNICAL SERVICES

- E1 MAINTENANCE
- E2 FOOD SERVICES
- E3 INSTITUTIONAL STORES
- E4 INSTITUTIONAL SERVICES

GROUP F – OCCUPATIONAL DEVELOPMENT PROGRAMS

- F1 OCCUPATIONAL DEVELOPMENT PROGRAMS (ODP) CORE
- F2 ODP PRODUCTION

GROUP G – EDUCATION AND PERSONAL DEVELOPMENT

- G1 EDUCATION
- G2 PERSONAL DEVELOPMENT
- G3 LIBRARY

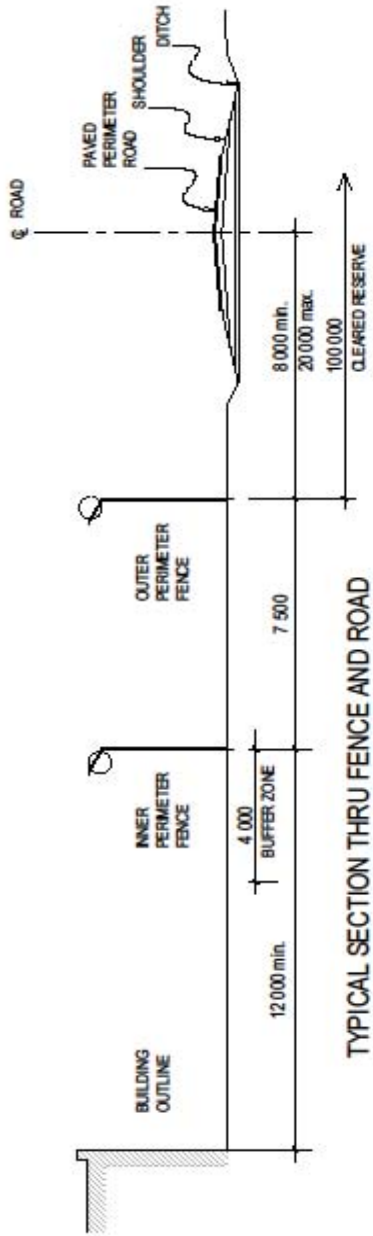

TYPICAL SECTION THRU FENCE AND ROAD

PLATE SP -1-2 - SECTION THROUGH FENCE AND ROAD

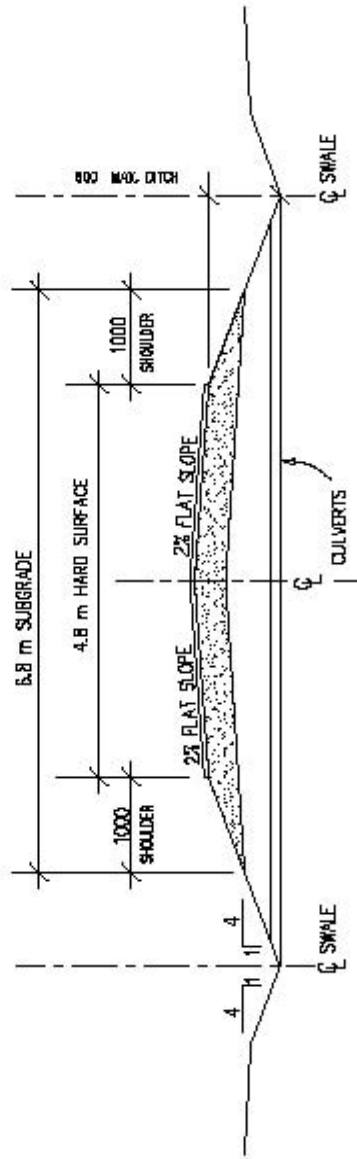

PERIMETER ROAD TYPICAL SECTION

PLATE SP-1-3 – ROAD SECTION DETAIL

SP-2 SITE - FENCE

1. SCOPE

This section provides performance criteria and conforming specifications for all fences associated with institutions of security levels medium, maximum and multi-level inclusive. There are no special requirements for fences at minimum institutions.

2. RELATED SECTIONS

2.1 *Technical Criteria Document sections:*

SP-1 – Site Development
SP-3 – Gates/Sallyports
SP-5 – Traffic Circulation and Parking
SP-6 – Site Lighting
SP-7 – Double Fence Lighting
ST-1 – Guard Towers
& any sub-section referring to the Perimeter Intrusion Detection System (P.I.D.S.)

2.2 *National Master Specification Section*

01 35 13.16 – Special Project Procedures for Detention Facilities
28 01 10 – Operation & Maintenance of Electronic Access Control & Intrusion Detection
28 16 00 (13705) – Intrusion Detection
32 31 13 – Chain Link Fences and Gates
32 31 13.53 – High-Security Chain Link Fences and Gates

3. EXTERNAL BOUNDARY FENCES

External boundary (property) lines shall normally not be fenced unless specific site conditions warrant it. The type of fence in such locations will be project specific.

4. PERIMETER SECURITY FENCES

4.1 *Performance Criteria*

- 4.1.1 The institution will be enclosed by a double chain link fence perimeter supported by intrusion detection and camera system, and mobile patrol on the exterior of the perimeter. The perimeter fences form the last physical obstacle to escape from the institution. The design of the fence system shall be such that an escapee shall not be able to breach the perimeter in less than 45 seconds. This time duration is based on a maximum time for the perimeter security mobile patrol to respond after the first signal following a detected disturbance of the fence at the Main communication control post (MCCP). The optimal reaction time for the mobile patrol is 30 seconds.
- 4.1.2 Fences shall be erected in straight lines from corner to corner for direct viewing by camera. The corners of the perimeter shall be truncated at 45° to allow suitable placement of camera poles and cameras to afford optimal viewing

between the fences and on the interior of the Inner Perimeter Fence. In addition, the truncated corners allow for a gentler curve of the patrol road.

- 4.1.3 To render climbing more difficult, the fence fabric shall be installed on the institution side of the fence posts. Sharp corners of less than 120°, shall be avoided except where fences intersect.
- 4.1.4 For fences equipped with a Fence Detection System (FDS), the fence shall balance fabric tension to ensure fabric vibration travel across posts while not causing excessive false alarms. Fabric vibration terminates at strain post locations where the fence fabric ends thus allowing zone separations for the PIDS.
- 4.1.5 Special attention shall be paid to sloped sites to ensure that gaps do not develop between the ground surface and the lower fence rail. Where necessary, due to severe ground slope longitudinally, fencing may be stepped, but the minimum height of the fence shall be maintained at all times. Ground slope across the fence line shall be minimized to prevent erosion under the perimeter fences
- 4.1.6 Water shall be prevented from pooling between the perimeter fences, as this could affect the operation of the Motion Detection System (MDS). For special underground drainage requirements relating to perimeter fences, see sections SU-1 Storm and Sanitary Sewers.
- 4.1.7 Barbed tape concertina (BTC) wire shall be installed in such a manner that it prevents the passage of a person across the barbed coils. (See plates SP-2-2 and SP-2-3).
- 4.1.8 For interior fences intersecting the Inner Perimeter Fence, the interior fence shall be designed to prevent it from being used to aid in crossing the Inner Perimeter Fence. To achieve this, the interior fence shall be equipped with:
 - a Fence detection system (FDS) for a length of 2.5 meters. The fence fabric shall extend for that length and be connected to a strain post so that the vibration does not travel beyond.
 - and BTC on both sides on the fence No gap between posts or fabric shall exceed 125 mm.
- 4.1.9 To inhibit tunnelling under the Inner Perimeter Fence, a ground barrier shall be provided by installing either a continuous concrete footing or a concrete sidewalk on the institution side. (See Plate SP-2-1). Roadways crossing perimeter fence lines shall be topped with asphalt which also serves as a ground barrier.
- 4.1.10 The system of line, strain, corner and gate posts shall be installed to meet local environmental conditions, particularly those of wind and wet snow storms. To respond to these conditions, foundation calculations demonstrating performance which will meet site wind and snow conditions must be carried out.
- 4.1.11 Where a building or other structure interrupts the perimeter fence run, the design to ensure perimeter integrity shall be approved by the issuing authority.

- 4.1.12 Where a perimeter comprises or integrates a wall, the design to ensure perimeter integrity shall be approved by the issuing authority.

4.2 **Conforming Specifications**

- 4.2.1 Perimeter fences shall consist of two (2) parallel fences, erected in straight lines, with a 7.5-m gravel strip between the fence lines. For retrofit installations, where it has been proven that a lesser separation has been effective, the existing spacing shall be maintained. Height of both fences, excluding overhang arms, shall be 3.6 m. Corners shall be truncated and the maximum length of the interior fence on the truncated line shall be 25 m.
- 4.2.2 No structure, with the exception of the Gatehouse and guard towers, shall be closer than 12 m to the Inner Perimeter Fence.
- 4.2.3 The area between the perimeter security fences shall be free of topsoil and be graded to a slope of 2% from the interior to the Outer Perimeter Fence. The surface will then be covered with a filter fabric and topped with a mix of 0 mm to 20 mm crushed stone to a depth of 200 mm. For the Outer Perimeter Fence an area of 500 mm on each side of the fence shall be stabilized to a depth of 300 mm with a compaction of 95% corrected maximum dry density to hinder run off erosion and tunnelling by inmates.
- 4.2.4 All chain link fencing shall be installed in accordance with the *National Master Specification (NMS) 32 31 13*⁶ and *CAN/CGSB-138.3-96* standard⁷. Where there is a conflict between the NMS and this criterion, the TCD shall prevail.
- 4.2.5 Chain link fence fabric shall conform to the following specifications⁸:
- 4.2.5.1 Wire Size: 4.8 mm (min) (6 Gauge)
 - 4.2.5.2 Size of mesh: 50.8 mm
 - 4.2.5.3 Height of fence fabric: 3600 mm
 - 4.2.5.4 Barbed edges top and bottom
 - 4.2.5.5 Average mass of zinc coating to be not less than 610 g/m² of uncoated wire
 - 4.2.5.6 Breaking tensile strength to be 10,000 N·min.
- 4.2.6 Wire mesh shall be continuous from top to bottom and shall be applied on the institutional compound side of the posts.
- 4.2.7 Fence fabric shall be pulled taut before fixing in place. Tautness, when fixed in place, is to be established by pull tests. The application of a 12 kg perpendicular pull at the midpoint of the mesh panel (midpoint of posts/rails) shall show a displacement of no more than 30 mm from the fence at rest plane.
- 4.2.8 Posts, (corner, gate, strain, line) shall conform to *CAN/CGSB-138.2-96*⁹, galvanized steel pipe.

⁶ National Master Specification 32 31 13 – Chain Link Fences and Gates (2004/12/31), there is also specifically Masterformat reference number 32 31 13.53 for High-Security Chain Link Fences And Gates

⁷ CAN/CGSB-138.3-96 – Installation of Chain Link Fence

⁸ Refer also to: CAN/CGSB-138.1-96 – Fabric for Chain Link Fence

- 4.2.8.1 Posts shall be spaced a maximum of 2.5 m apart.
- 4.2.8.2 Line post minimal size shall be 73 mm O.D. 8.6 kg/m.
- 4.2.8.3 Strain post minimum size shall be 114.3 mm O.D. 15.92 kg/m. Strain posts shall be spaced not more than 60 m apart.
- 4.2.8.4 Corner and gate post minimum size shall be 150 mm O.D. 21.0 kg/m.
- 4.2.9 Galvanized steel arms shall be provided on all posts where barbed concertina is to be installed, as shown on Plate SP-2-2 and SP-2-3.
- 4.2.10 Bottom and top rails shall be 42.2 mm O.D. minimum, 3.4 kg/m.
- 4.2.11 Tie wires shall be 3.7 mm diameter (9 gauge) galvanized steel wire to secure chain link fabric to bottom rail, top rail and line posts at 300 mm spacing.
- 4.2.12 An intermediate galvanized anchor shall be used to secure the bottom rail to the ground barrier, where such a barrier is installed. This anchor shall limit vertical movement of the bottom rail to a maximum of 125 mm.
- 4.2.13 Intermediate rails shall not be used.
- 4.2.14 Tension bars used for holding the ends of the fence fabric at the location of strain posts and corner posts shall be 5 mm x 20 mm minimum x 3600 mm galvanized steel.
- 4.2.15 Tension bar bands shall be 3 mm x 20 mm minimum galvanized steel and spaced vertically at 300 mm o.c..
- 4.2.16 Where nuts and bolts are required for fastening, nuts shall face compound exterior and be torqued tight.
- 4.2.17 Where tension cables are used at corner, end, gate, strain posts, and fittings shall be of galvanized steel.
- 4.2.18 Barbed tape concertina (B.T.C.) shall be galvanized tape 20 x 0.5 mm clenched around a 2.5 mm diameter spring steel galvanized core wire to form a concertina coil with a nominal exterior coil diameter of 710 mm. The coil, when installed, shall have a minimum diameter of 635 mm. The barbed concertina shall have 20 mm long blade type barbs measured from tip to tip of the blade, and barb clusters shall be spaced approximately 45 mm on centre (see Plate SP-2-3). The concertina shall be formed by clipping adjacent loops of single helical coils together at a minimum of three (3) points on the circumference. Clips shall be galvanized. The resulting coil, when stretched, shall form a cylindrical pattern. The loop spacing shall not exceed 230 mm.
- 4.2.19 For concertina coil support at fence top, two barbed wires stretched and fixed to post arms shall be provided. Barbed wire shall consist of two strands of 12 gauge wire with 4 point barbs at 130 mm spacing, all galvanized.
- 4.2.20 Concertina coils are to be turned onto a secondary internal fence for a distance of 2.5 m when such a fence meets the perimeter fence. (See plate SP-2-6).

⁹ CAN/CGSB-138.2-96 -- Steel Framework for Chain Link Fence

4.2.21 Installation of barbed tape coils shall be as follows:

4.2.21.1 The barbed tape concertina is to be supported and tied at 230 mm spacing onto each of the barbed wire. Additional coils that are required on fences are to be tied as shown on Plate SP-2-3.

4.2.21.2 A second row of BTC may be installed on fence tops at existing sites due to local conditions with the approval of the issuing authority (see plate SP-2-3)

5. INTERIOR FENCES

5.1 Area and Yard Fences

5.1.1 Performance Criteria

5.1.1.1 Interior fences located at Maximum security institutions and those defining segregation yards at Mediums and Maximums shall be a maximum of 3.6 m in height topped with steel arms, barbed wire, and BTC. Other fenced areas at Medium Institutions may be topped with BTC where the fence separates inmate high activity and circulation areas from routine vehicle traffic movement. The use of BTC on top fences for any other location must be submitted for approval to the issuing authority.

5.1.1.2 Posts shall be provided with post caps where post arms are not provided.

5.1.1.3 Where interior fences intersect the Inner Perimeter Fence, refer to item 4.1.8 above and plate SP-2-6

5.1.1.4 Tunnelling barriers are not required on interior fences except where they are topped with BTC. Barrier type shall be compacted gravel to 500 mm on either side except where the yard is asphalted.

5.1.1.5 Fences shall not be used to demarcate the buffer zone.

5.1.2 Conforming Specifications

5.1.2.1 Materials shall be similar to those specified for the perimeter fences (see item 4.2).

5.1.2.2 Two coils of BTC shall be installed on the top of Segregation exercise yard fence as indicated on Plate SP-2-3. A flat solid wall shall be provided where visibility and contact is at issue with approval of the issuing authority.

6. SEPARATION OF DISTINCT POPULATIONS IN ONE INSTITUTION (MULTI-LEVEL)

6.1 Types of Multi-level and Fencing Needs

Multi-level institutions vary in the type of populations they accommodate. Two populations such as minimum and medium may be fully integrated with no physical separation or fencing required. Control and supervision is managed through operational means.

A second type of multi-level institution accommodates several populations, short term and assigned to a specialized program. Inmates here have limited access to the institution at large and have restricted movement. The housing units accommodating these populations are generally self-contained integrating staff and related program areas including yards. These units do not require fenced separation as movement outside of the units are under escort and limited to individual or small groups. Yards for these units are fenced and topped with BTC.

A third type of multi-level is where a distinct smaller population as part of a specialized program remains largely in their unit and does not mix with the general population which has normal movement to program and activity areas. The specialized program unit is also self-contained which includes yards. The yards of this unit are fenced and topped with BTC while the complete unit is separated from the rest of the institution by a fence but without BTC topping. The fenced yards here do not form part of the separation fence.

6.2 *Conforming Specification*

Specifications are similar to those for the Inner Perimeter Fence (item 4), including the requirement for a single concertina on top of the fence. The steel arms for yards where one roll of BTC is used are always oriented toward the yard it encloses.

7. EXTERIOR SERVICE COMPOUND FENCE

7.1 *Performance Criteria*

Where bulk fuel storage (propane and gasoline) is provided, the storage area shall be fenced (see section SP-5, Traffic Circulation and Parking).

7.2 *Conforming Specifications*

7.2.1 Materials will be similar to those specified for the perimeter fences (item 4).

7.2.2 Fence height shall be 2.5 m.

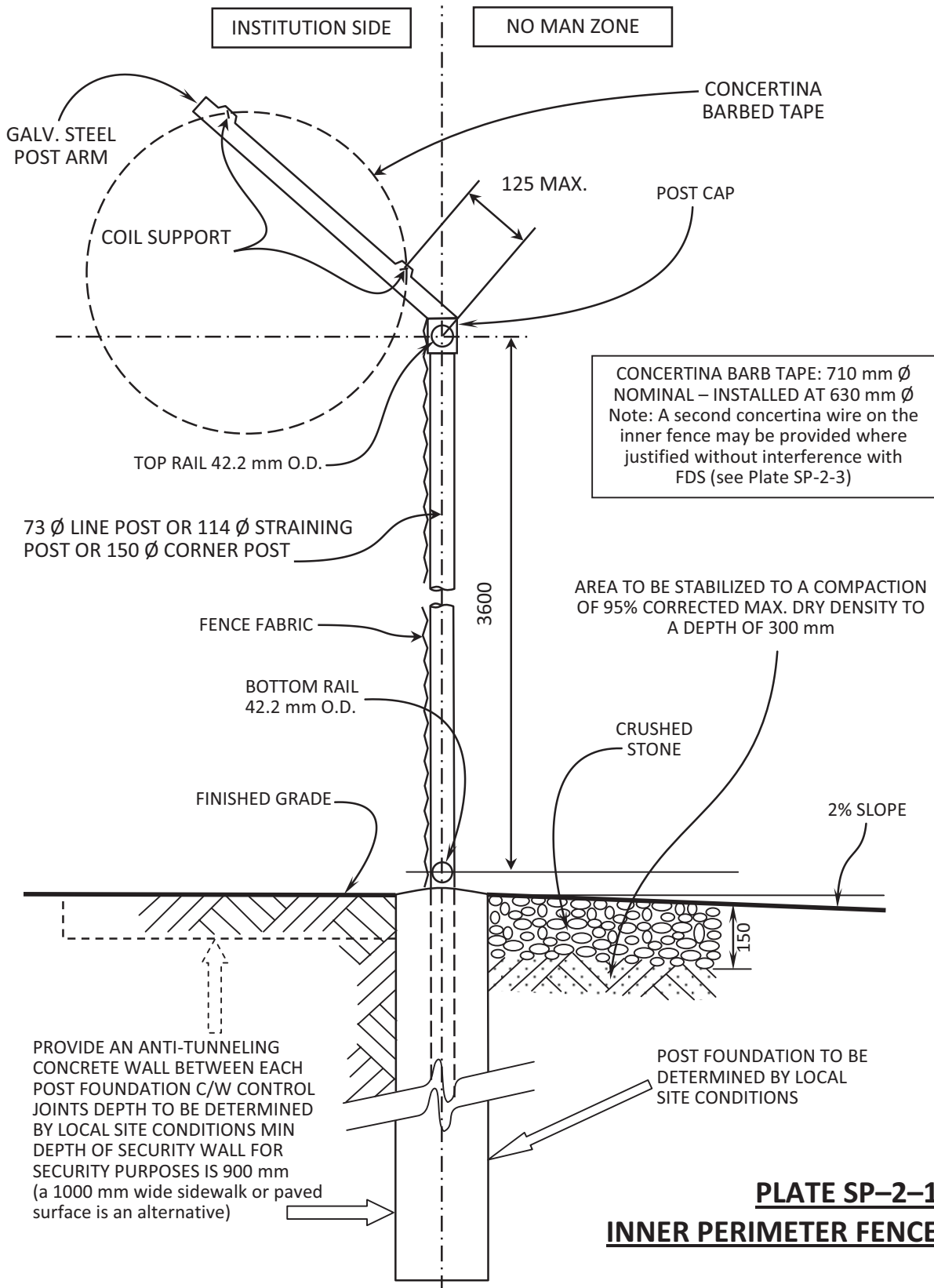
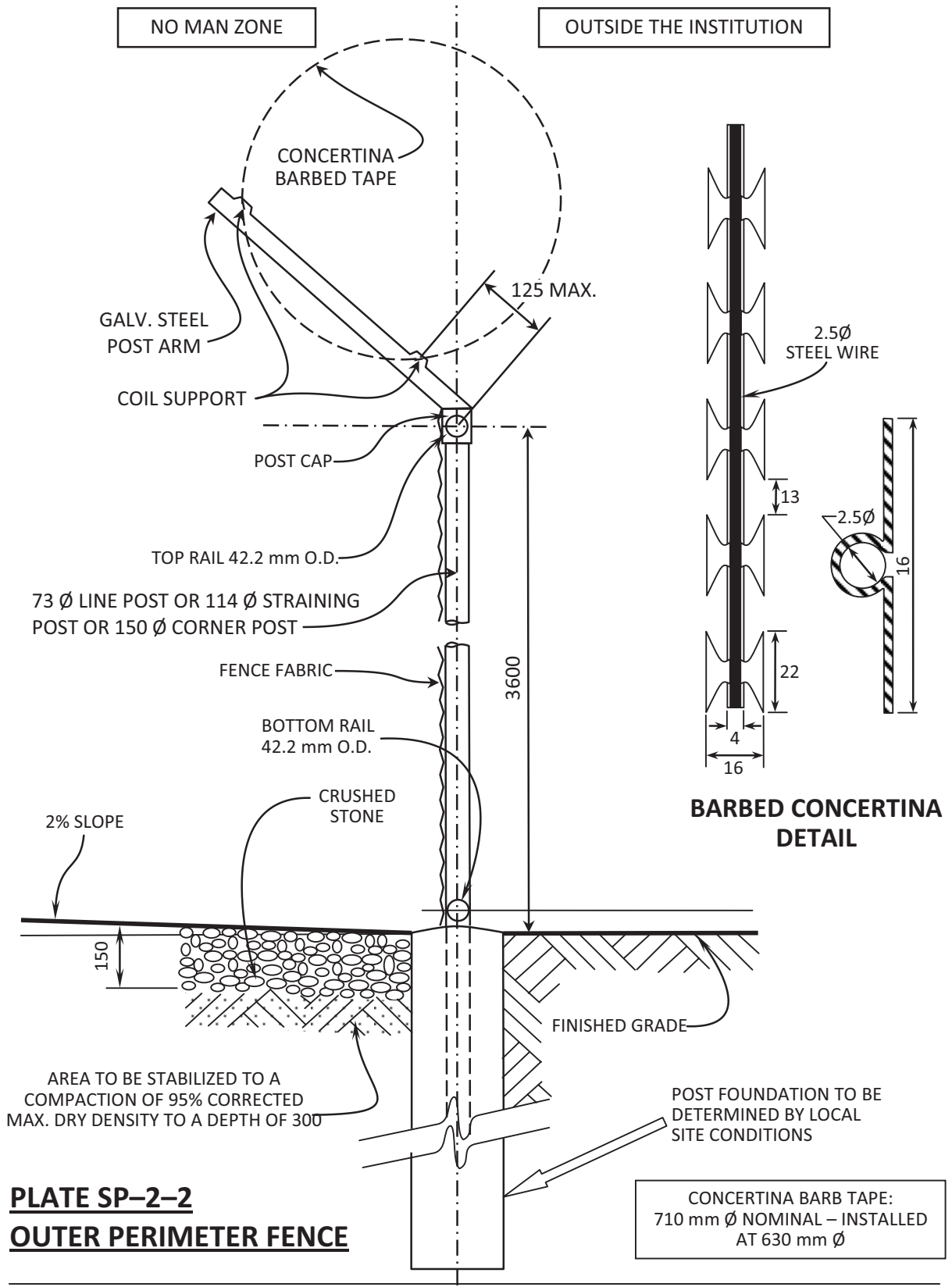

PLATE SP-2-1
INNER PERIMETER FENCE



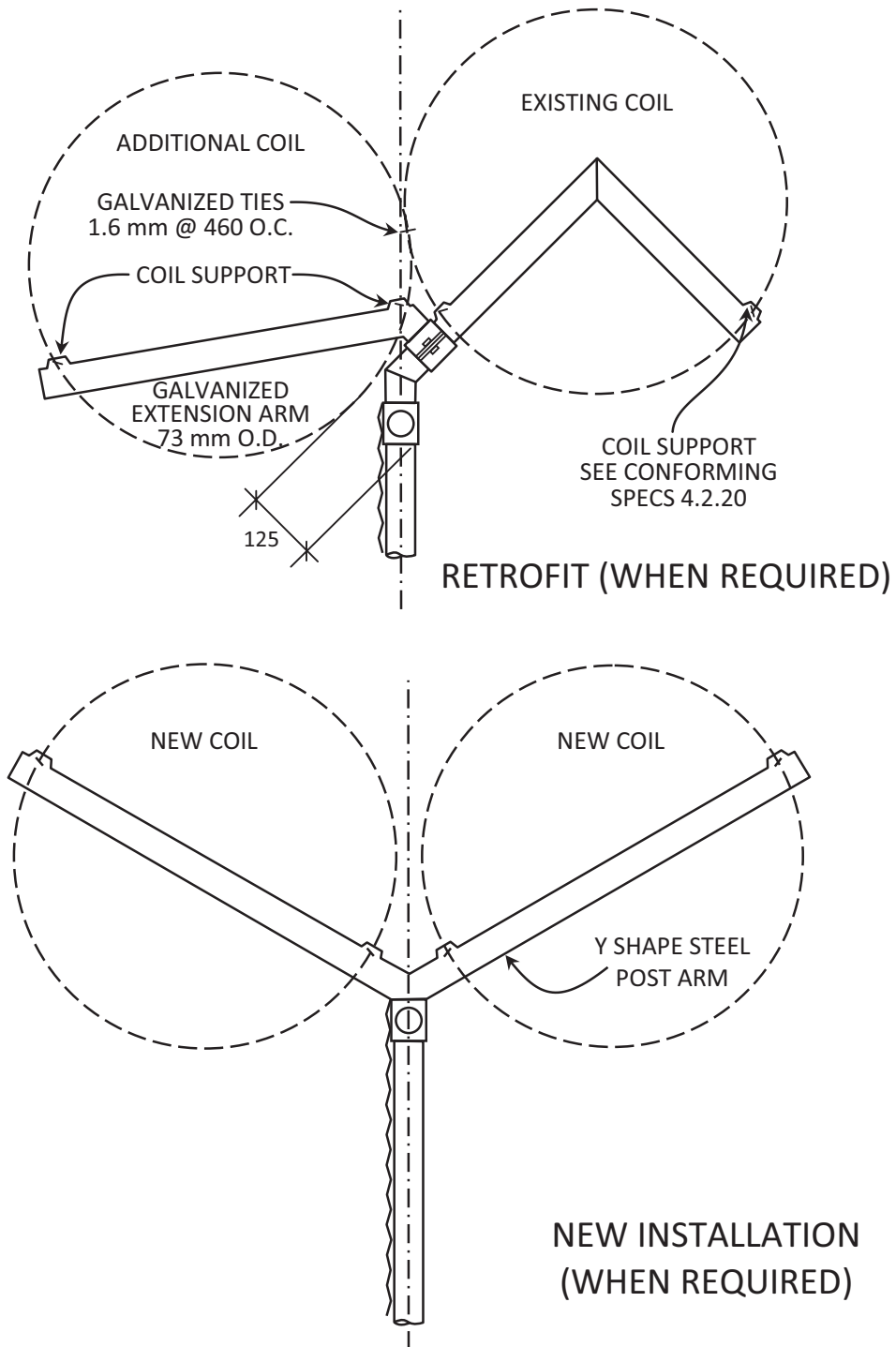

PLATE SP-2-3 – INNER FENCE WITH A SECOND CONCERTINA TAPE

CONCERTINA BARB TAPE: 710 mm Ø NOMINAL – INSTALLED AT 630 mm Ø

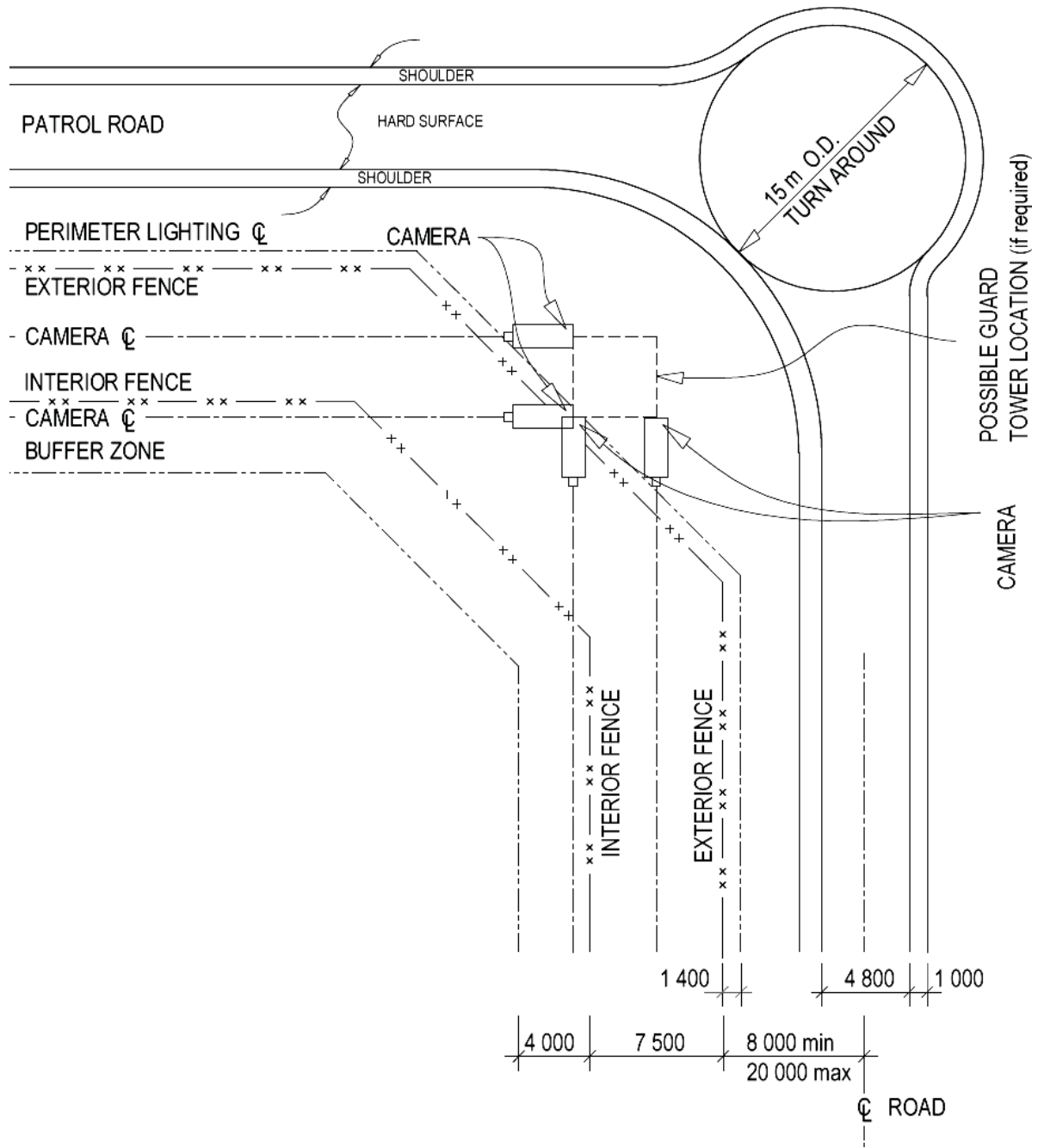
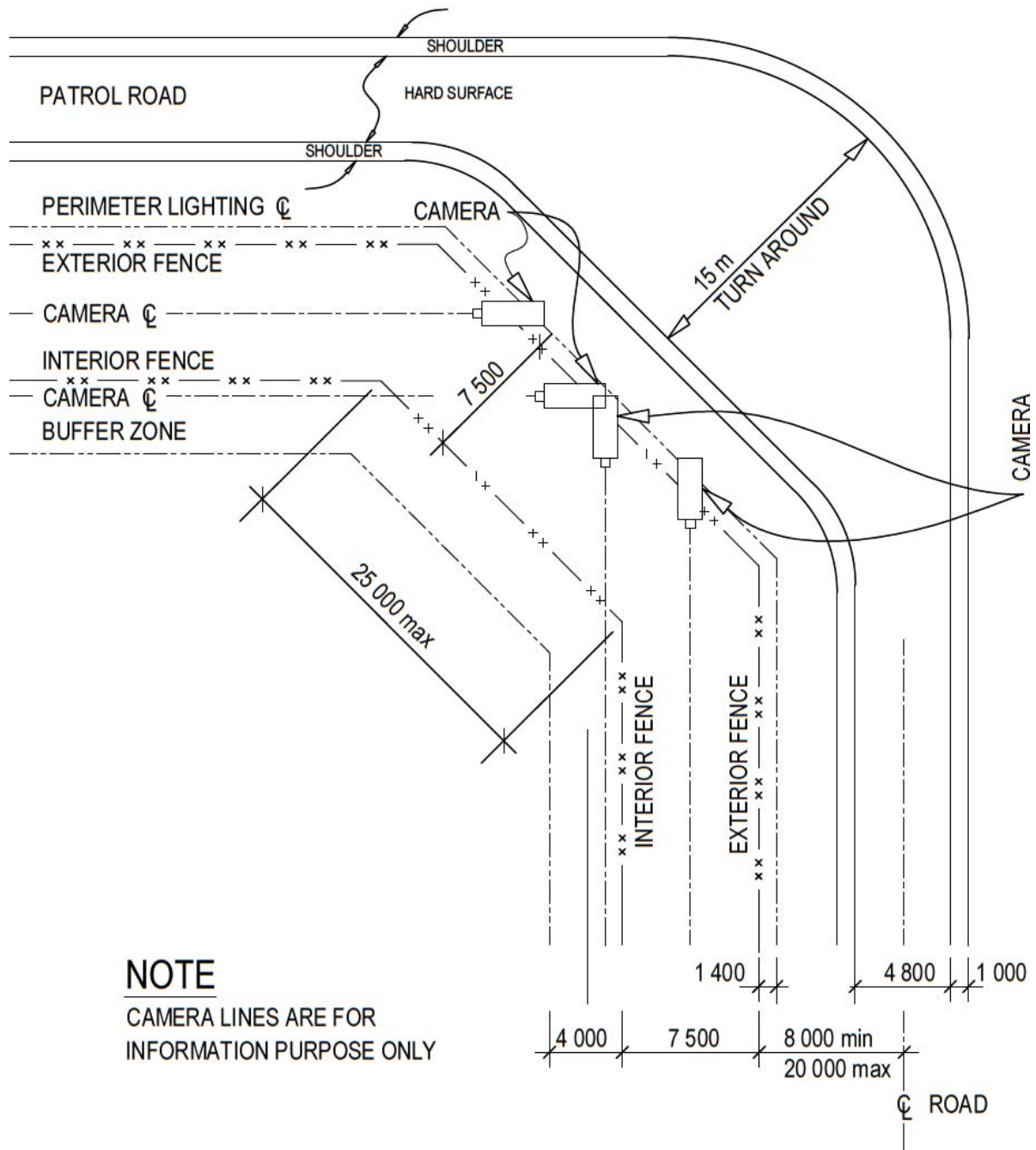

PLATE SP-2-4 – TYPICAL PERIMETER FENCE CORNER WITH TOWER

Note: Camera lines are for information purpose only



NOTE
CAMERA LINES ARE FOR
INFORMATION PURPOSE ONLY

PLATE SP-2-5 – TYPICAL PERIMETER FENCE CORNER WITHOUT TOWER

CAMERAS ARE MOUNTED ON OUTRIGGERS OVER THE CONCERTINA

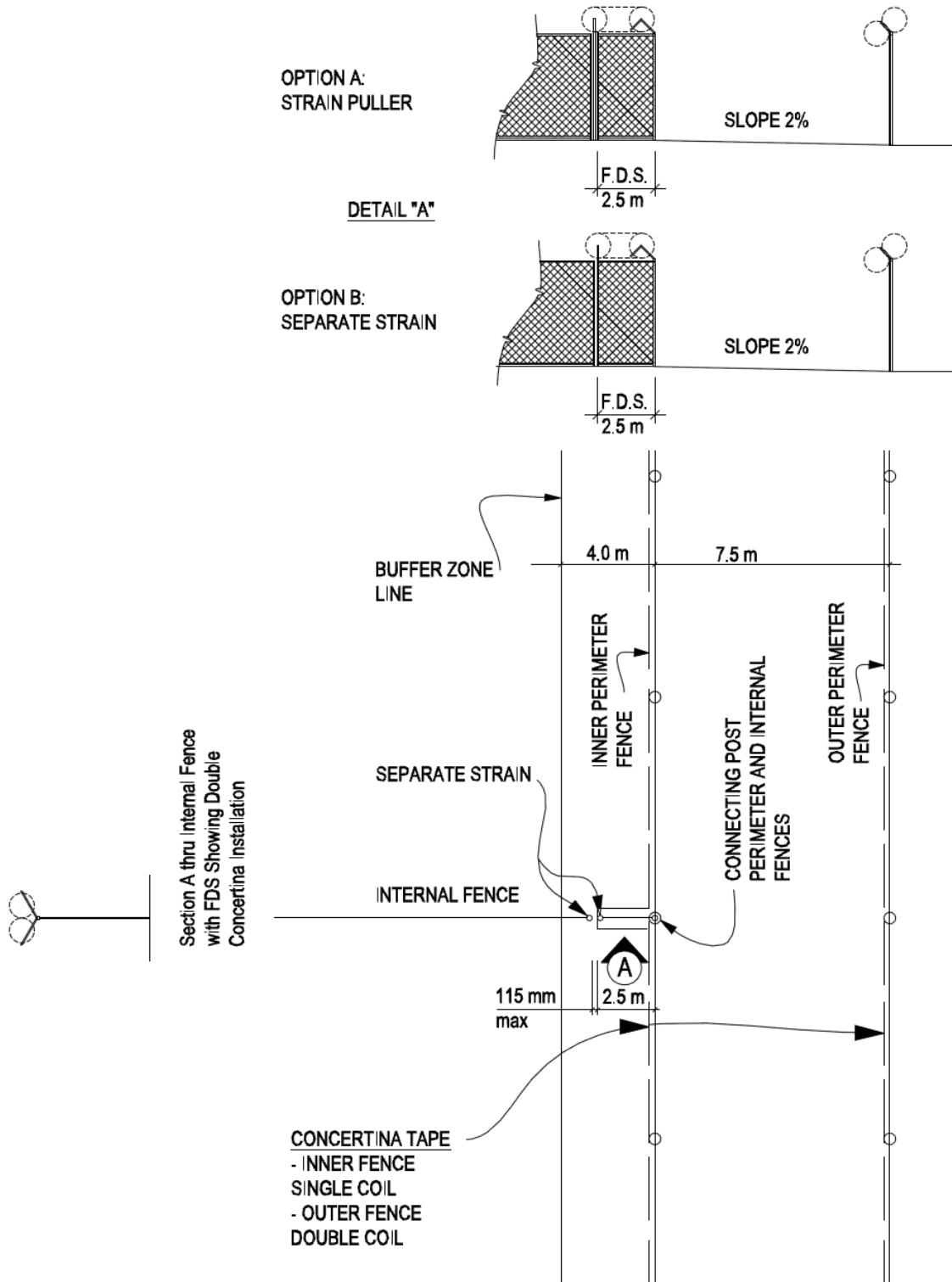

PLATE SP-2-6 – INTERNAL FENCES INTERSECTING WITH THE PERIFERAL FENCES – DETAILS

SP-3 SITE – GATES/SALLYPORT

1. SCOPE

This section outlines requirements for vehicle and pedestrian access and egress control for institutions with a secure perimeter as at medium, maximum and multi-level institutions.

Access and egress control for open minimum institutions involves signage and reporting to a 24 hr Duty office but does not include fencing and gates. Refer to A-12 Control posts for functional requirements as well as the CSC Accommodation Guidelines.

2. RELATED SECTIONS

7.3 *Technical Criteria Document sections:*

SP-1 – Site Development

SP-2 – Fences

A-6 – Hardware

A-10 – Contraband Control Systems

A-12 – Control Posts and Dedicated Security Routes

2.1 *National Master Specification Section*

01 35 13.16 – Special Project Procedures for Detention Facilities

08 34 56 – Security Gates

32 31 13 – Chain Link Fences and Gates

32 31 13.53 – High-Security Chain Link Fences and Gates

34 71 13 – Vehicle Barriers

34 71 13.16 – Vehicle Crash Barriers

34 75 13.13 – Active Vehicle Barriers

2.2 *ASTM Standards*

F2656-07 – Standard Test Method for Vehicle Crash Testing of Perimeter Barriers

3. ACCESS CONTROL SECURITY REQUIREMENTS

3.1 All new institutions equipped with a fenced perimeter shall have one entrance point for pedestrian and vehicle traffic, referred to as the Principal Entrance.

3.2 Because the Principal Entrance may at some time be inoperable, one Emergency Vehicle Entrance shall be provided, to be located at a point convenient for vehicle access. This Emergency Vehicle Entrance can have either a Sliding Gate (Section 5.1) or a Swing Gate (Section 5.2).

3.3 Vehicle access shall be provided into the area between the inner and Outer Perimeter Fences for snow clearing and maintenance of the Motion Detection System (MDS). Snow build up between the fences can adversely affect the operation of the MDS.

4. PRINCIPAL ENTRANCE

4.1 *Definition*

The Principal Entrance is formed by a Gatehouse for pedestrian traffic control and an open air chain-link fence compound with inter locking gates for vehicle traffic control (vehicle sallyport). The Gatehouse contains the Principal Entrance Control Post and a reception station from which staff supervise all traffic in and out of the institution and operate by remote control all gates and doors. For detailed requirements see A-12 Control Posts and Dedicated Security Routes. At institutions where a separate vehicle service entrance sallyport exists, sallyport gates are remote operated from an adjacent tower or a post within the sallyport. The tower or ground post officer also observes the inspection of vehicles and assures the safety of the vehicle inspection officer.

- 4.1.1 All vehicle sallyports shall be equipped with sliding gates. The sliding gates shall be remote controlled from the Principal Entrance control post and interlocked to prevent simultaneous unlocking. The sliding gates control must provide for the opening of one of the gate only when the other gate is in its latched position. Both gates shall be also capable of manual unlocking and opening.
- 4.1.2 Vehicle sallyports shall be sized to include an inspection area, to facilitate a thorough inspection of vehicles, which can hold in width two van type trucks (8.5 m min.), and hold one semi trailer truck in length (23 m min.).
- 4.1.3 In order to prevent forced drive through of vehicles, the exterior gate of the vehicle sallyport shall be equipped with a crash barrier (see section 4.4 and Plates SP-3-6 to SP-3-8).
- 4.1.4 All Principal Entrance pedestrian traffic shall be physically separated from vehicular traffic.
- 4.1.5 Where vehicle access into the area between the perimeter fences is provided from the vehicle sallyport, the gates shall be swing type, manually operated and lockable.
- 4.1.6 All pedestrian traffic through the Principal Entrance, including traffic between the vehicle sallyport and the pedestrian sallyport, shall be through swing gates. Principal Entrance pedestrian gates shall be remote unlocking, self closing and locking, and capable of manual unlocking.
- 4.1.7 To allow continuous CCTV coverage of the area between the perimeter fences while maintaining a minimum number of cameras, the Gatehouse building shall be sited on the outside of the Outer Perimeter Fence with one face of the building flush with that Outer Perimeter Fence.
- 4.1.8 See Plate SP-3-1 for a typical Principal Entrance layout.

4.2 *Crash Barriers*

- 4.2.1 Crash barriers for sallyport sliding gates shall be connected to the interior side of the exterior gate and shall be operated simultaneously with the remote operation of the gate.
- 4.2.2 In order to resist vehicle impact, crash barriers shall be made of an I-beam or rectangular tubing supported on anti friction rollers with a minimum of three (3) heavy uprights. In a test equivalent to the US Department of State K4 certification¹ (6 804 kg @ 48.3 km/hr or 15,000 lbs @ 30 mph) the vehicle must be inoperable after hitting the crash bar. The main purpose of the beam is to cause maximum damage to ramming vehicle.
- 4.2.3 The first heavy upright supports the crash barrier extension opposed to the opening, the second upright supports the crash barrier extension on the side of the opening and acts as a protection bollard for the inside post of the opening and for the gate operator when a rack and pinion system is in use. The third upright supports the crash barrier only in its closed position and acts as a protection bollard for the outside post of the opening. At any time the crash barrier is supported by the first and second uprights.
- 4.2.4 If crash barriers are used for emergency gates on the perimeter, they shall be made of a simple beam or rectangular tubing with a counter weight mechanically lifted and lockable in closed position with the use of a security padlock.
- 4.2.5 Gate having integrated crash bar or crash cables system are acceptable if they meet M30 designation of *ASTM F2656-07*², K4 certification of the US Department of State (see footnote 1) or the European equivalent³.
- 4.2.6 See Plates SP-3-3 to SP-3-6 for typical sallyport crash barrier.

5. FENCE GATES

5.1 *Vehicle Sliding Gates*

- 5.1.1 The size of each gate shall provide for a 4 m wide x 4.5 m high clear opening.
- 5.1.2 Gate chain link fabric shall match perimeter fence. (See section SP-2, Fences).
- 5.1.3 Gate framing members shall be 73 mm O.D. pipe weighing 8.6 kg/m welded and drained.
- 5.1.4 Motorized gates shall be capable of moving at a speed of 150 mm/s.
- 5.1.5 Gate shall have three point locking (top, bottom and middle).
- 5.1.6 Locking column shall be equipped with an emergency manual control mechanism located for easy access.

¹ US Department of State SD–STD–02.01, Revision A , March 2003, Test Method for Vehicle Crash Gate Testing of Perimeter Barriers and Gates

² ASTM F2656–07, Standard Test Method for Vehicle Crash Testing of Perimeter Barriers, M30 Designation: Medium-duty truck (M) 6800 kg @ 50 km/h

³ BSI – PAS68:2010 – Impact test specifications for vehicle security barriers, January 2010. Most of the British manufacturers refers primarily to this standard, but in general also mention the USDS equivalent

- 5.1.7 Operator and track shall be protected and electrically heated to ensure all weather operation. In rack and pinion system (or “drive rail” operator) the teeth of the rack can be unprotected provided that they are on the lower side of the rack and visible to the operator. Where crash beams are installed on a sliding gate, the additional weight shall be taken into account.
- 5.1.8 For gates operated by an overhead chain drive system, a guide shall be provided at the bottom of the gate running in a channel.
- 5.1.9 Motors shall be located low to the ground to facilitate maintenance
- 5.1.10 All gate components shall be galvanized.
- 5.1.11 All security hardware shall be in accordance with chapter A-6, Hardware of the present document. All other components shall be in accordance with the Fences section of this criterion.
- 5.1.12 See Plates SP-3-2 and SP-3-3 for a typical gate installation.

5.2 Vehicle Swing Gates (Perimeter and Internal Fences)

- 5.2.1 Gates shall consist of a pair of 2 m wide by 4.5 m high sections, for an opening of 4 m wide X 4.5 m high, except where municipal by law or sufficient height and width for local emergency vehicles (fire trucks) dictate otherwise⁴.
- 5.2.2 The swing direction of gates shall be determined after consideration of operational and snow conditions.
- 5.2.3 Any gap between the bottom rail of a gate and the ground shall not exceed 125 mm. Where gates are located on a fence equipped with a ground barrier, this barrier shall be continuous.
- 5.2.4 The chain link fabric for gates shall match the fence on which it is mounted (see section SP-2, Fences).
- 5.2.5 Gate framing shall be as per item 5.1.3 above.
- 5.2.6 There shall be three gate hinges and they shall be of standard quality. Foot and mid height locking shall be accomplished with Southern Folger detention grade locks or equivalent.
- 5.2.7 Plate SP-3-7 illustrates a typical design for vehicle swing gate.

5.3 Pedestrian Gates (Perimeter and Internal Fences)

- 5.3.1 The size of each swing gate shall provide for a 1.2 m wide x 2.1 m high clear opening.
- 5.3.2 Items 5.2.2, 5.2.3 and 5.2.4 noted above for vehicle swing gates shall apply.
- 5.3.3 Swing gate framing members shall be 43 mm O.D. pipe weighing 3.4 kg/m.
- 5.3.4 Swing gates shall be manually operated with security key locks when gates are used daily. Principal Entrance gates shall be remote unlocked and equipped with closers. Infrequently used gates shall be security padlocked.

⁴ For example, in Ontario the *Highway Traffic Act* Section 109 stipulate a maximum height of 4.15 m by a width of 2.6 m, which is similar to the 13'-6" (4.12 m) by 8 (2.43 m) in USA.

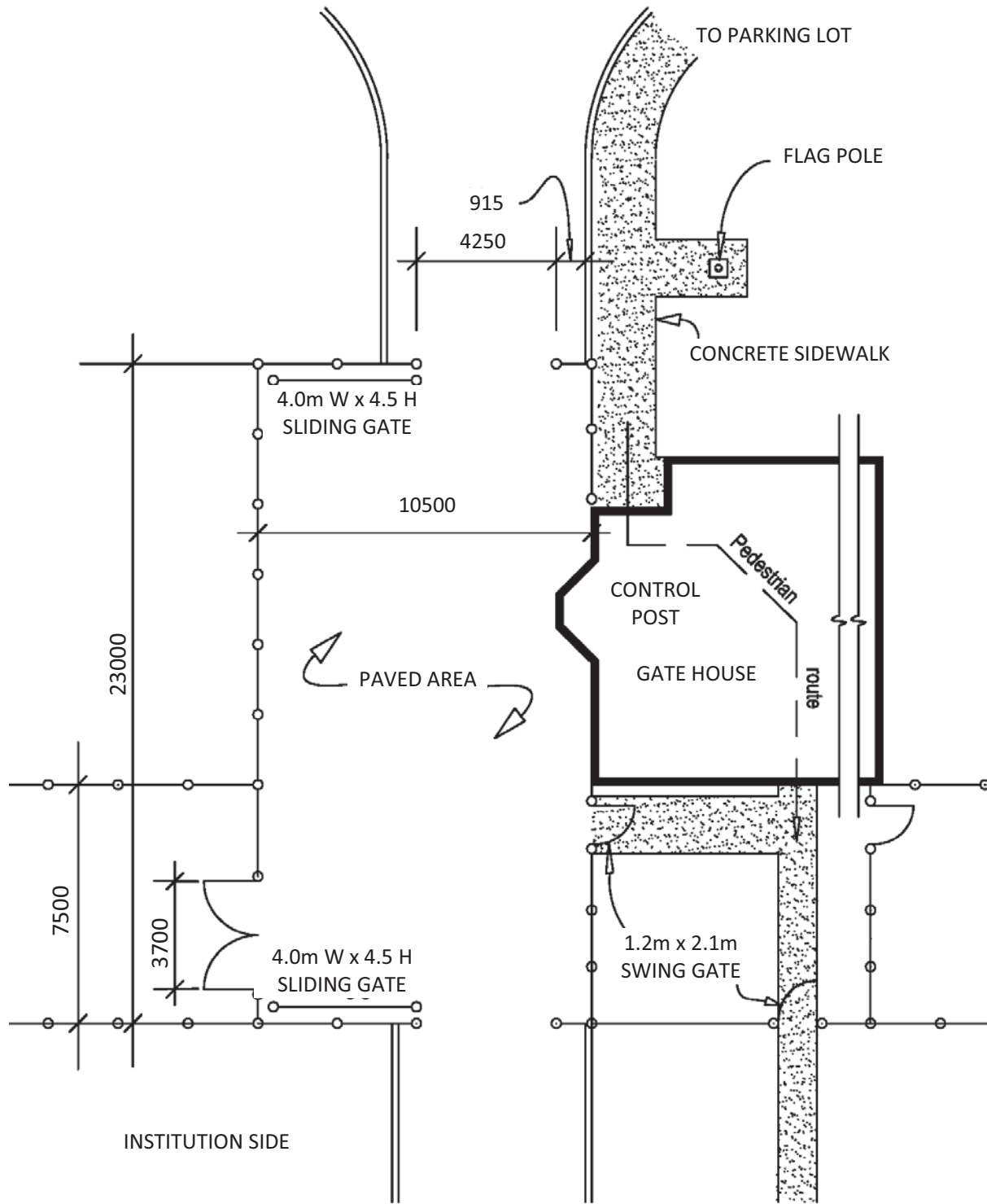
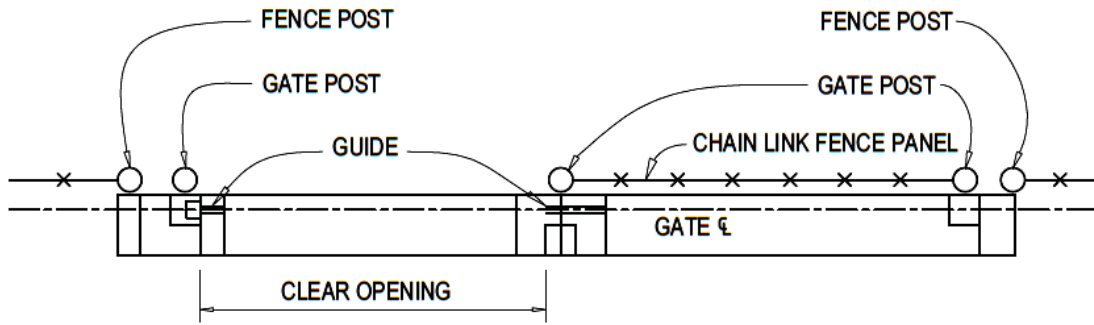
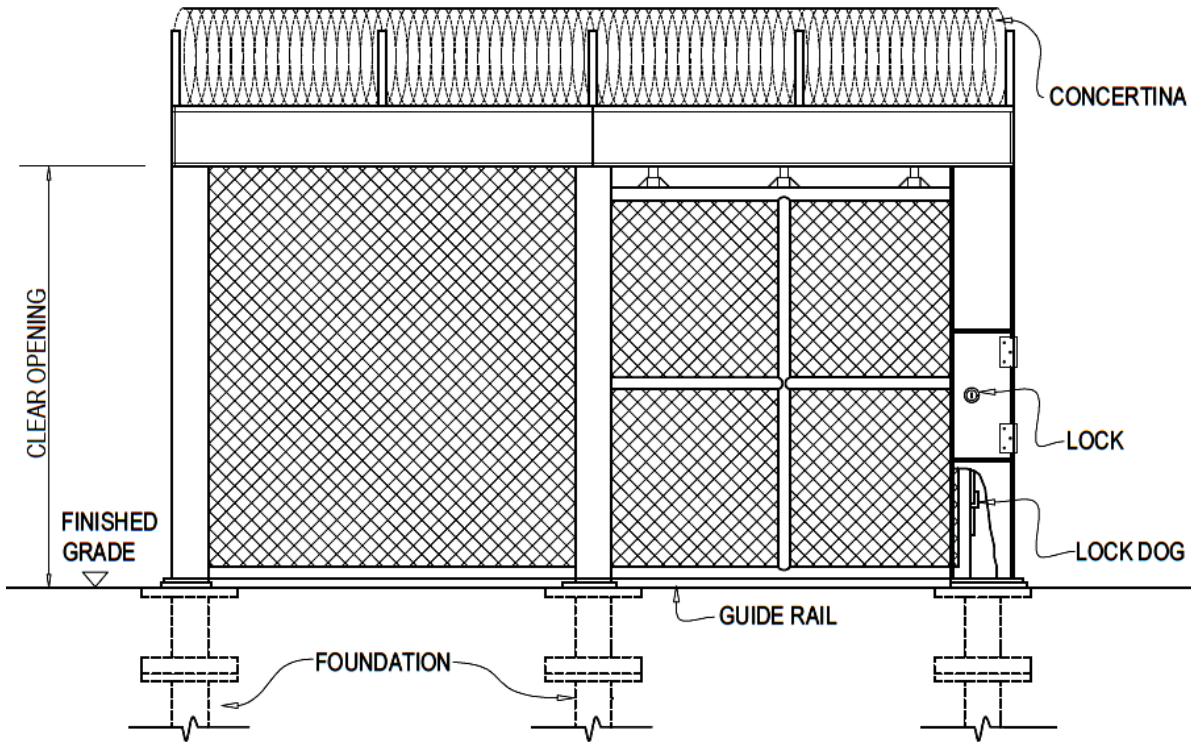

PLATE SP-3-1 – TYPICAL SALLY PORT ARRANGEMENT



TOP VIEW



FRONT VIEW

PLATE SP-3-2 – FENCE GATE WITH OVERHEAD CHAIN DRIVE
INNER PERIMETER FENCE

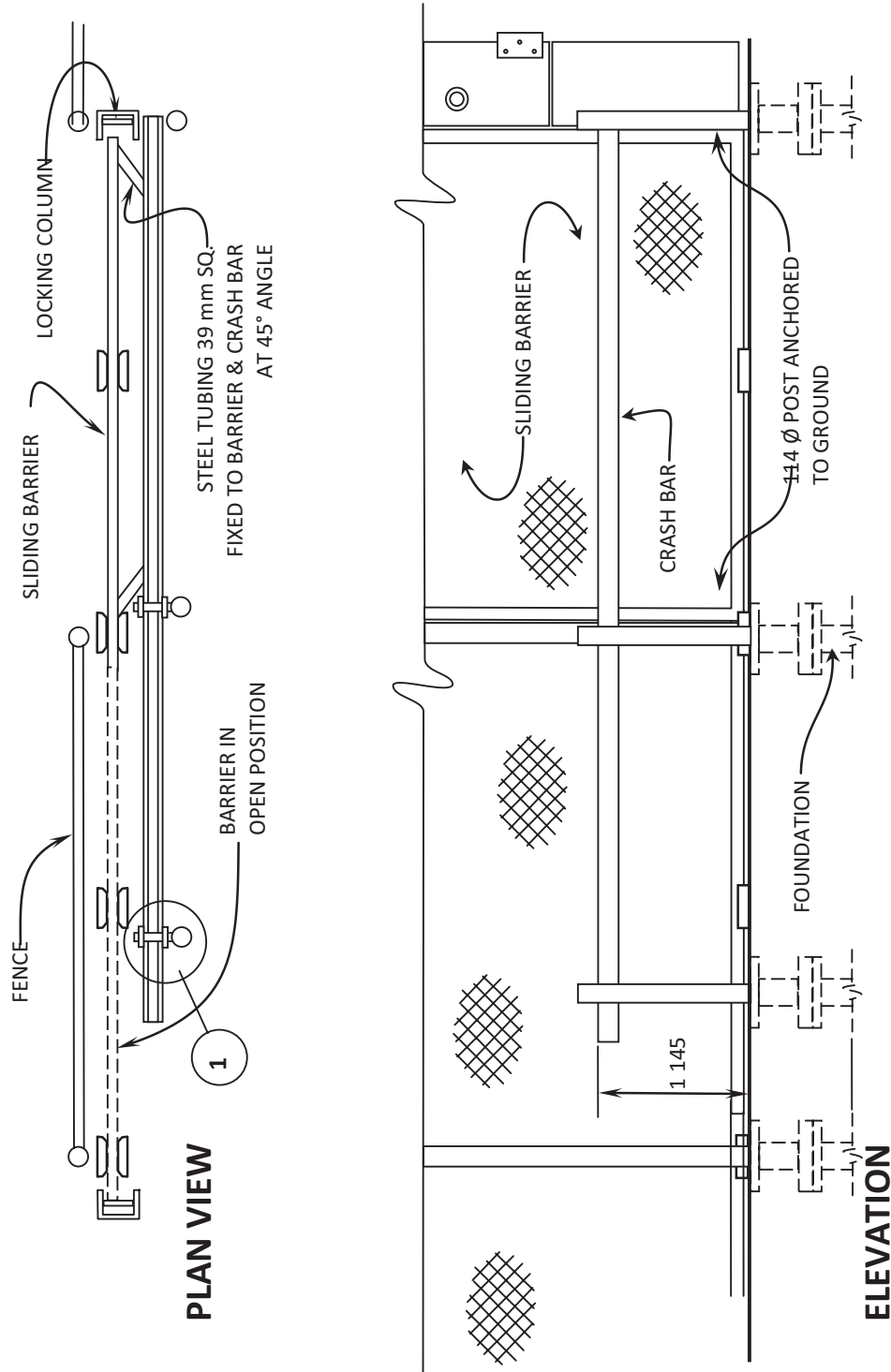

**SP-3-3 – FENCE GATE WITH OVERHEAD CHAIN DRIVE
EXTERIOR PERIMETER FENCE**

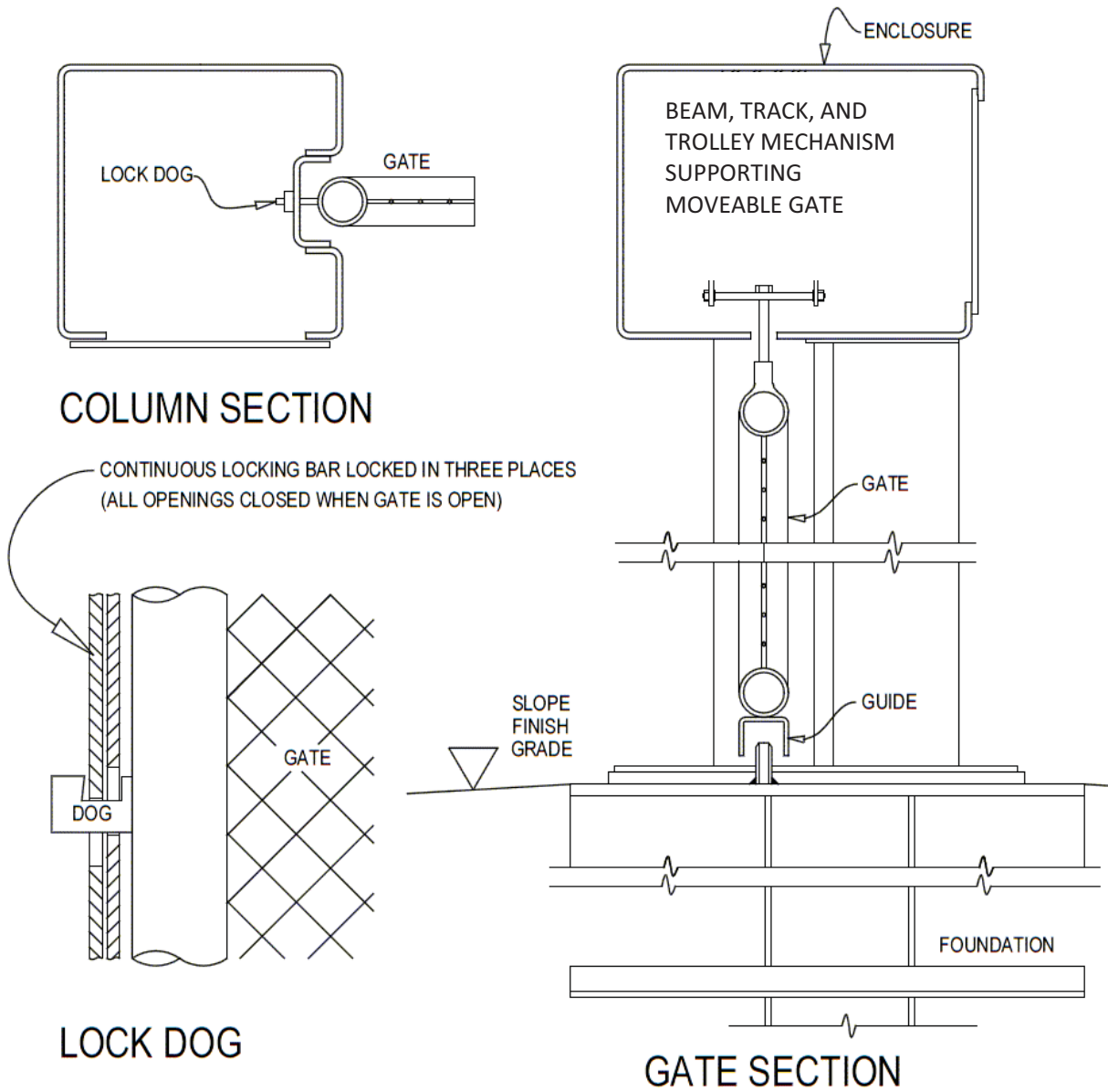

PLATE SP-3-4 – FENCE GATE WITH OVERHEAD CHAIN DRIVE – DETAILS

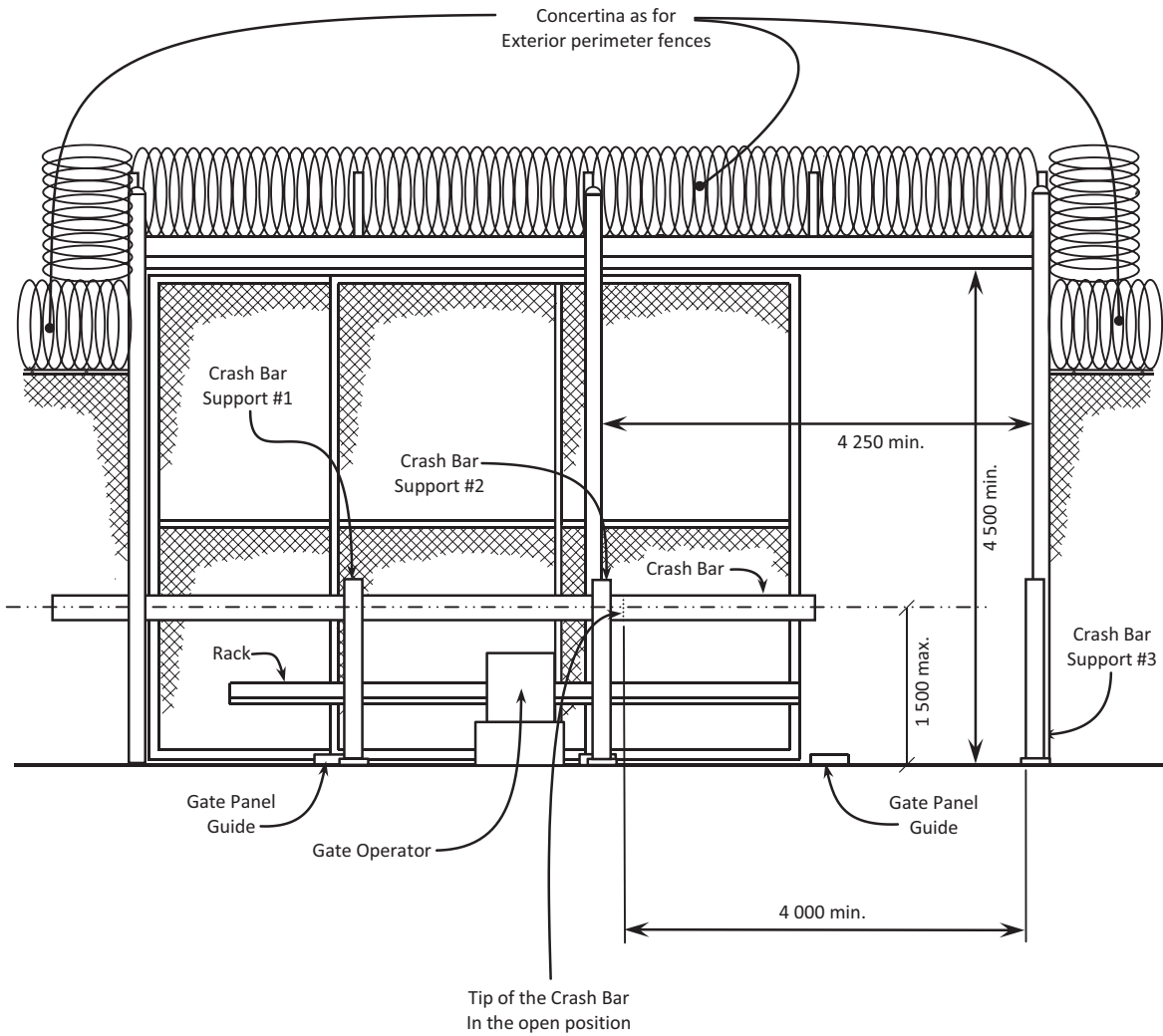

PLATE SP-3-5 – FENCE GATE WITH RACK & PINION –
INSIDE ELEVATION OUTER PERIMETER FENCE

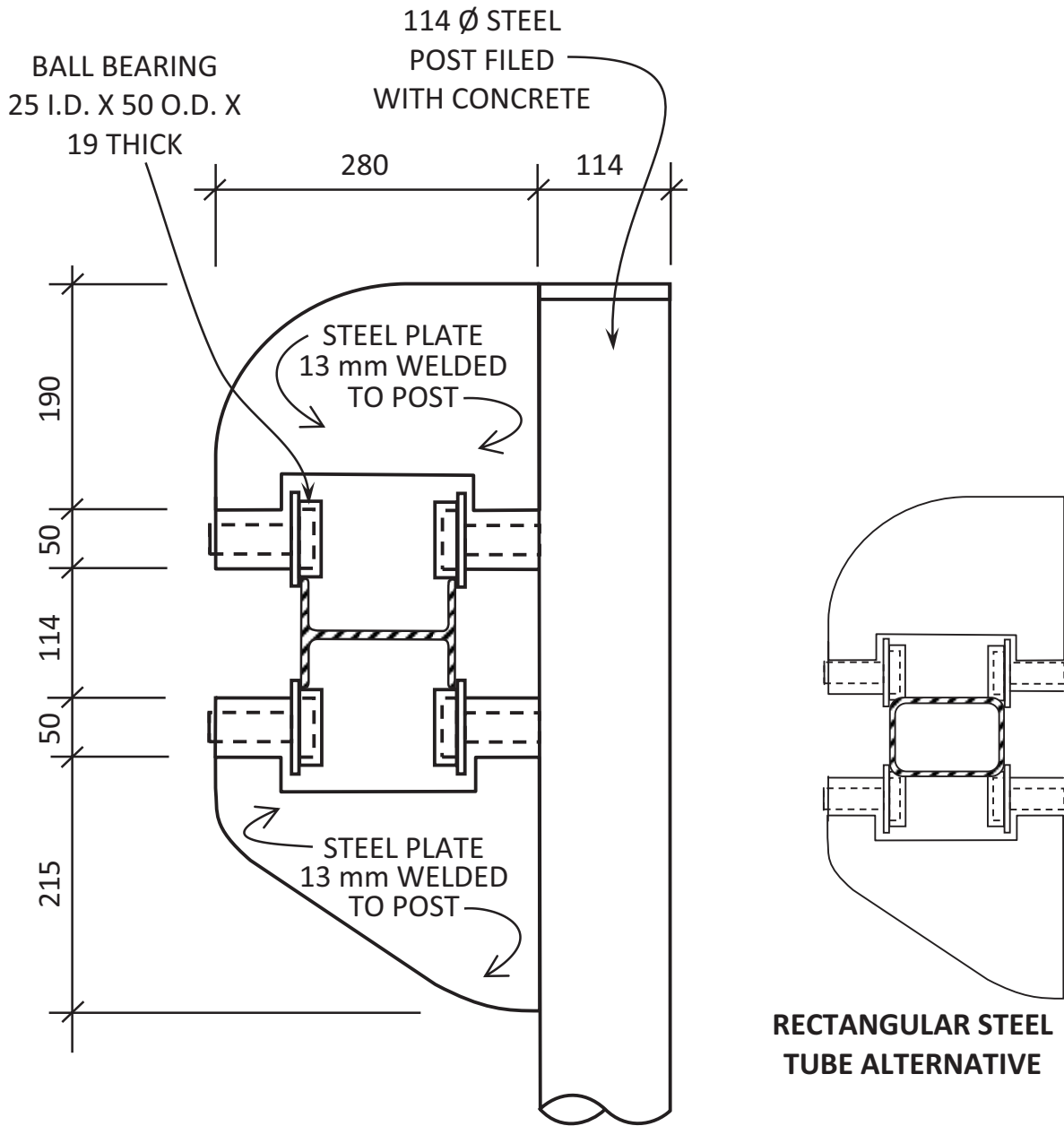

PLATE SP-3-6 – CRASH BAR DETAILS

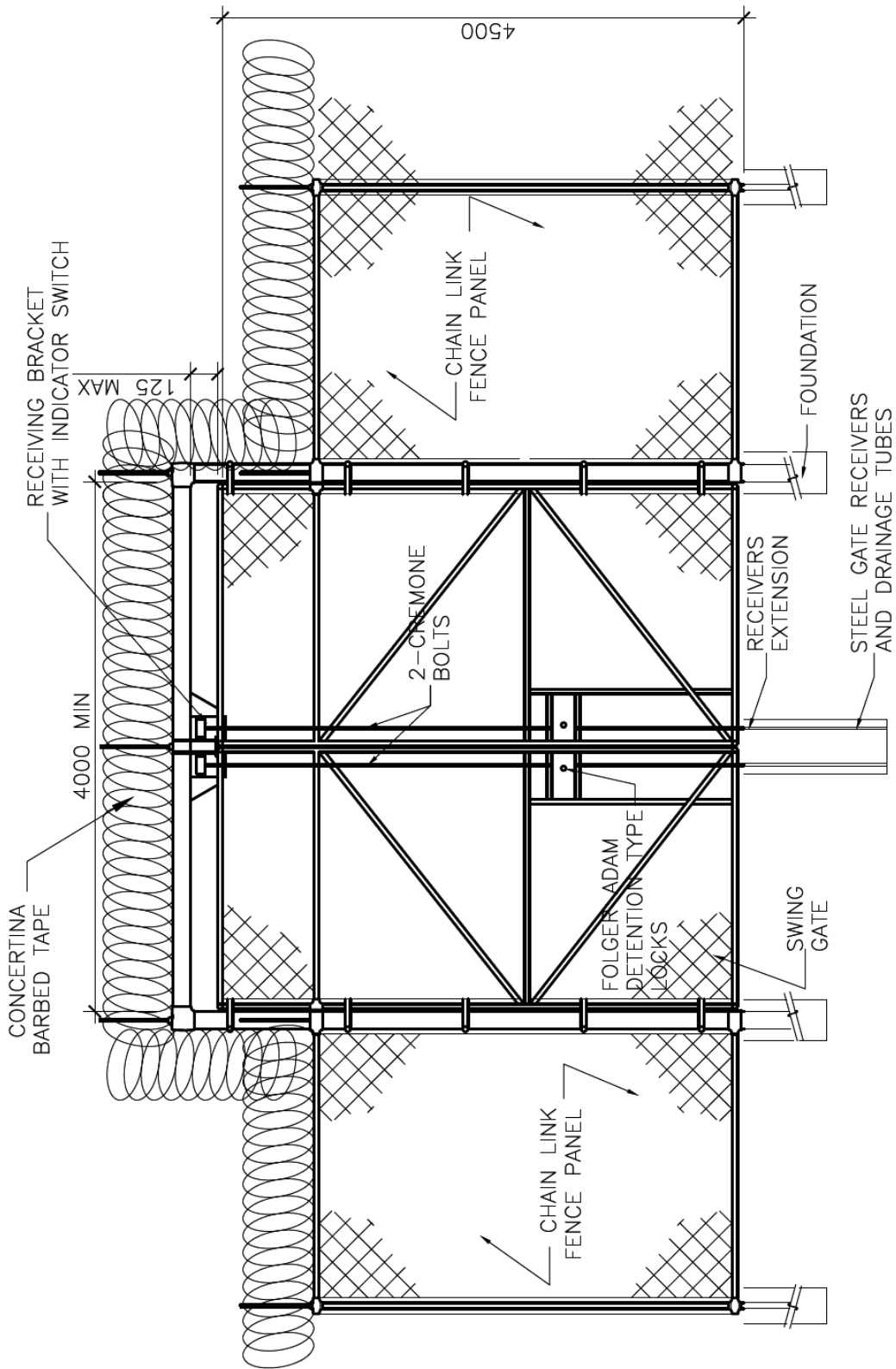

PLATE SP-3-7 – VEHICLE SWING GATE (EMERGENCY GATE)

SP-4 SITE – EXTERIOR LIGHTING

1. SCOPE

This section outlines the requirements for site lighting including perimeter fence lighting and provides design guidelines for the following:

- Type of lighting systems and standards.
- Recommendations for lighting levels.
- Quality of illumination.
- Recommendations for control of glare.
- Recommendations for uniformity and brightness control of the environment.
- Recommendations for maintenance of the lighting system.

2. RELATED SECTIONS

SP-2 – Fences

SP-5 – Traffic Circulation

E-1 – General Electrical Engineering and Electrical Distribution

E-7 – Emergency Electrical

ST-1 – Guard Towers

3. GENERAL REQUIREMENTS

- 3.1** Design exterior lighting to preclude glare, at least to minimize glare in the eyes of guards, and compatible with the architecture of the building and with each other. Enable the CSC Staff and Inmates to move in safety in designated areas, as identified on a project specific basis. Assist the Staff in the visual detection of attempts to escape.
- 3.2** Exterior lighting should be so designed as to minimize light entering sleeping spaces.
- 3.3** All exterior lighting systems will be designed so that systems will supplement each other, free of shadows or dark spots, to provide silhouetting for surveillance purposes and to facilitate observation from strategic areas.
- 3.4** Energy saving features are to be used in accordance with government policy.
- 3.5** Use the PWGSC Standard on graphic symbols for electrical drawings. Some of the symbols are publicly available on page 10 of the PWGSC National CADD Standard Supplement¹.
- 3.6** Reference to levels of illumination in this Document refer to average and avg./min. ratio values whether it is horizontal illumination at ground level or vertical illumination, unless otherwise stated. These are minimum values and special consideration may be necessary to compensate for local and adverse atmospheric conditions.
- 3.7** Lighting is not used alone to deter or detect attempts to escape by inmates. It must therefore be compatible with and complement other methods applied, such as T.V. monitoring, alarms systems, observation towers, vehicle patrol, etc.
- 3.8** Design the systems to withstand a wind velocity of 160 km/h and ice loading characteristic of the area in which the institution is located.

¹ PWGSC National CADD Standard Supplement – National Capital Area Operations – Professional and Technical Services, March 2010
http://www.tpsgc-pwgsc.gc.ca/cdao-cadd/cn-nc/dossiers-files/PWGSC_CADD_Standards_NCA-OPS-Supplement-E_v1.1.pdf

- 3.9** Provide automatic control and manual override for all security lighting systems. The manual override shall reset itself to the automatic operation after it has been left in the manual position for 24 hours. The recreational lighting control shall be manual only.

4. APPLICATIONS

Exterior lighting is designed to provide illumination of the following:

- Signs
- Entrances, including exterior stairways and ramps.
- Pedestrian walks.
- Grounds.
- Parking lots and roadways.
- Outdoor recreation areas.
- Roof maximum security institutions only.
- Perimeter fence.

5. PERFORMANCE REQUIREMENTS

5.1 Security Lighting

5.1.1 Location and Connection to Emergency Power Source

The following are security lighting systems and as such they shall be connected to the emergency power source.

5.1.1.1 Perimeter Fence Lighting System – Due to the special requirements of the perimeter system it is covered in detail under section 5.2.

5.1.1.2 Building roof for Maximum institutions. These areas are to be illuminated to 10 lx. This level of illumination is intended to provide silhouetting for surveillance of building roofs when required.

5.1.1.3 Medium and Maximum institution areas bounded by security fences are to be illuminated to 10 lx average to allow silhouetting surveillance. This includes the entire area within the Inner Perimeter Fence.

5.1.2 Illumination

5.1.2.1 Entrances and Sallyports should be illuminated so that the security officers may observe and recognize visitors who wish to enter the institution or leave during hours of darkness. No fixture should be mounted where it can direct light into the officers' eyes and thus reduce their ability to see the person wishing to pass through. Entrances and Sallyports should be illuminated to the same level of intensity as the perimeter fence with supplementary lighting installed and operated only as required.

5.1.2.2 The security lighting system should ensure that the areas directly illuminated are brighter than the immediate surrounding areas.

5.1.2.3 Glare Control – Where control of spill light becomes necessary due to glare experienced after the installation is completed; specify that Contractor mount shields or visors on the luminaires, providing the required “cut off” for glare control. Where visors are used the luminaires must be so designed that they can be attached simply, quickly and securely without affecting the strength of the luminaire. A careful study of the geometry of the lighting system during the design

stages should be undertaken to determine where spill light might produce a problem. Ensure that the minimum illumination levels are not affected.

- 5.1.2.4 Uniformity – The placement of the luminaires should be arranged so as to ensure good uniformity of illumination over the area illuminated. Uniformity is expressed as the ratio of average illumination to minimum. In the area between fences the ratio should not exceed 3:1 Medium and Maximum Institutions. Adherence to the layout shown in references will permit achieving the desired results.
- 5.1.2.5 Luminaires – Exterior security lighting fixtures shall be based on the following requirements:
 - a) Shatterproof lenses and vandal resistant housings.
 - b) Non yellowing lenses.
 - c) Post, luminaires and brackets capable of withstanding the force of 160 km/h wind.
 - d) Specify that exterior lighting fixtures be located so as to facilitate replacement of components and to minimize vandalism.
 - e) Use high mast type of fixture for roof lighting, entrances, etc. wherever possible to minimize glare.
- 5.1.2.6 Electrical System – The electrical system must meet the following minimum requirements.
 - a) The security lighting system including the perimeter fence lighting shall be connected to the standby power system to ensure the greatest continuity of service.
 - b) Grounding methods shall meet the requirements of the Canadian Electrical Code, *CSA C22.1-09*².
 - c) Design the systems so that each phase is protected by its own single phase circuit breaker. This is to prevent the possibility of a fault on one phase affecting the other two.
- 5.1.2.7 Codes and Standards – The essential requirements and minimum standards for the installation of Double Fence Lighting are established by the latest edition of the Canadian Electrical Code, Part 1, *CSA C22.1-09* (see footnote 2) and any local or provincial regulations which may apply. Under no circumstances, however, shall the requirements of the present Document be reduced.

5.2 Perimeter Fence Lighting

5.2.1 General

- 5.2.1.1 Security Lighting for Perimeter Fences shall be designed to accomplish the following:
 - a) Discourage or deter escape attempts.
 - b) Make detection certain should an escape be attempted within the immediate area of the perimeter fence.

² CSA C22.1-09 -- Canadian electrical code, part I (21st edition), safety standard for electrical installations.

- c) Avoid glare that can dazzle the security staff and annoys street and highway traffic, marine and railroad operations, and the surrounding area.
- d) Provide high system reliability.
- e) Provide the levels of illumination indicated in Plates SP-4-2 and SP-4-6.
- f) Provide automatic control.
- g) Consist of poles, lighting equipment and components located outside the double security fences and being made inaccessible to persons attempting malicious damage to the equipment.
- h) Be connected to the standby power system to ensure the greatest continuity of service.
- i) Provide a monochromatic light source -- a doublet of 589 nm and 589.6 nm for TV surveillance of the area between and adjacent to the double fences.
- j) Provide minimum illumination level of 10 lx to the exterior edge of the perimeter road (typically between 5 m and 15 m from the bottom of the light poles).

5.2.2 Design

Design the Perimeter Fence Lighting System and specify equipment and components to achieve and maintain lighting quality based on the following factors and considerations:

- 5.2.2.1 Take into consideration the fact that the amount of illumination required at night to see a person in detail is higher than the amount required to see a person silhouetted against a light background in daytime. Many institutions are located in areas well removed from cities and towns with little other source of light. It is necessary, therefore, to provide sufficient light to enable the potential escapees to be seen in detail within the illuminated area of the fence line.
- 5.2.2.2 The height of the perimeter fences, 3.6 m (12'), and the distance between fences, 7.5 m (24.6'), and the height and physical arrangement of sentry outposts and/or guard towers, are important factors to be considered in the design of the applicable security lighting system. These factors dictate the height of the poles, the mounting height of the luminaries and the installation methods to be used. Refer to Plates of this Document for the required illumination levels.
- 5.2.2.3 Plates SP-4-2 & SP-4-6 present maintained levels of luminance within the illuminated areas at ground level. They would occur when the fixtures are dirty and the lamps are at their lowest output approximately 80% of their rated life. A suitable maintenance factor should be included in the design calculation to make allowance for luminaire dirt, depreciation and lamp lumen depreciation. Foggy weather conditions will also adversely affect visibility. As such the level of illumination should be increased or a factor applied in the calculation to ensure that under poor visibility lighting serves to enhance vision.

5.2.2.4 Local conditions such as position of cameras etc. may require elevating and/or increasing the number of light fixtures required in certain areas to accommodate the camera viewing. Special attention must be paid in the double fence corner area.

5.2.3 Luminaires

5.2.3.1 Luminaire type – Low Pressure Sodium or Light Emitting Diode (LED) are the two lighting systems used on Perimeters. These will normally be fully operable between -40°C (or less) and + 50°C (or more). For new installations, LED lighting is the choice system for the following reasons. Because of the white and bright light quality which enhances vision, LED systems can be integrated with the PIDS to allow the lighting to run at two illumination settings: low and high. Lighting could normally run at the low setting but should the inner fence be disturbed as detected by the FDS, the lighting in that zone only could increase to the high setting. This will signal to the escapee that his attempt has been detected and to the mobile patrol, the location of the disturbed zone. The lighting could therefore operate at 50% power increasing to 100% power at the disturbed zone. This reduces the power output even beyond its already highly efficient performance. See Plate SP-4-6 for LED layout.

5.2.3.2 Sodium-type Luminaires, Lamps and Ballasts – When Sodium type of lamps are selected for the catenary system, considers the following requirements:

- a) Luminaire to accommodate one 135 W SOX low pressure sodium lamp, operated from a remote ballast. Use Philips SDP 828 or approved equal.
- b) Specify a luminaire with a “unitized” cast aluminium housing free of welds, butt joints and lapped corners having a baked enamel finish, and an anodized aluminium reflector and a clear acrylic refractor.
- c) Specify a Type HRC fuse rating to be as specified by the ballast manufacturer and to be installed in the transformer base for the protection of each luminaire.
- d) Specify luminaire having stainless steel hardware on the outside and corrosion resistant finish of all materials inside the fixture.
- e) Specify a luminaire having an optical system protected by a neoprene gasket to keep out dust and moisture.
- f) Specify guard for protection against excessive vibration by using a porcelain lampholder and a spring steel plastic coated lamp support.
- g) Specify each luminaire to have a 135 W SOX low pressure sodium lamp in a T-21 bulb providing 21,500 lm output (minimum) and an average rated life of 15,000 hours.
- h) Specify ballasts designed and manufactured to meet *CSA C22.2 No. 74-96 (R2005)*³, *ANSI Standard C82.1-2004*⁴ and CBM Standard.

³ CAN/CSA-C22.2 No. 74-96 (R2005) – Equipment for Use with Electric Discharge Lamps

Rated voltage to match supply voltage should be specified to match current and voltage ratings of the lamps they are designed to operate. Ballasts to have a power factor correction to 90% or more.

- i) Specify ballasts designed to operate 135 W low pressure SOX sodium lamps at minus 40°C and to maintain lamp wattage within 8% of nominal with a supply line fluctuation of 20%.
- j) Specify ballast of constant wattage auto transformer type.

5.2.4 Poles

- 5.2.4.1 Specify octagonal tapered steel poles complete with transformer bases, eye bolts and a gasketed electrical outlet boxes.
- 5.2.4.2 Specify poles to be hot dipped galvanized on both interior and exterior surfaces as per *ASTM A123-09*⁵.
- 5.2.4.3 Specify pole height and luminaire spacing as shown on Plates SP-4-3 & SP-4-7 at the end of this section. Specify hot dipped galvanized anchor bolts and hardware accessories where possible.
- 5.2.4.4 Specify a (hardwood plywood template for retaining anchor bolts when grouting them in place in the concrete base.
- 5.2.4.5 Specify a non-shrink grout.
- 5.2.4.6 Ensure that the transformer base plates are drilled in the manufacturer's plant to match the anchor bolt configuration sets in the bases.
- 5.2.4.7 Ensure that the access doors in the transformer bases are gasketed and use tamperproof hardware for securing doors in place.
- 5.2.4.8 Specify that the transformer base be oriented so that their access doors are parallel to but facing away from the fence.
- 5.2.4.9 Specify yellow PVC guards to be installed on the guy wires on the anchor poles terminating the linear sections of the spans.
- 5.2.4.10 Workmanship (Poles) – Specify that all castings and steel fabrication be made in a good workmanship like manner. Specify that Contractor employs properly qualified and certified welders, and that after all welds are made, cut edges, projections or sharp corners and edges be ground to a smooth surface prior to finishing and that the poles and transformer bases be thoroughly cleaned.
- 5.2.4.11 Shipment and Delivery (Poles) – Specify that the poles and transformer bases, complete with all hardware, be suitably packaged to provide adequate protection and that all components be shipped and delivered as a unit. Poles should be supported throughout their length during transportation and when stockpiled must be supported so that they are not bent under their own weight. Specify the use of wooden block supports if necessary.

⁴ ANSI C82.1-2004 – American National Standard for Lamp Ballasts – Line Frequency Fluorescent Lamp Ballasts

⁵ ASTM A123 / A123M – 09 – Standard Specification for Zinc (Hot-Dip Galvanized) Coatings on Iron and Steel Products (CSA G164 has been withdrawn)

- a) Grounding Requirements (Poles) – Specify that a 10 mm threaded copper grounding stud be welded to the inside of each transformer base at the back and above the bottom of the door opening. Ensure that ground studs are supplied each complete with two nuts, one lock washer and one copper clamp type lug for minimum 13 mm² stranded bare copper wire.
- b) Specify that the ground studs be welded to the transformer bases in such a manner as to present a smooth surface on the exterior of the bases.

5.2.4.12 Markings – Specify that each pole has an aluminium nameplate located one foot above its base. The nameplates are to include the manufacturer's name or identification mark, year of manufacture, pole length and ordering reference number.

5.2.4.13 Shims – Specify that each pole be provided with one 1.5 mm shim and two “U” shaped 3 mm shims for levelling.

5.2.4.14 Pole Installation – In designing and specifying the pole installation consider the following requirements and sequence:

- a) The poles should be stripped of the wrappings only after they have been transported to the site and are ready for erection.
- b) The transformer bases must be mounted first on the concrete bases and then the poles are to be erected and mounted on the transformer bases in the following manner:
 - i. Before erection, the bottom of the transformer bases and the bottoms of the pole bases should be coated with at least two coats of bituminous paint. Coating must be free from imbedded impurities.
 - ii. The transformer bases should be bolted to the concrete foundations.
 - iii. Conductor cables should be pulled into the transformer bases.
 - iv. The poles should be lifted onto the transformer bases orienting same to ensure that eye bolts and electrical outlet boxes are in the correct positions.
 - v. The anchor bolts should be installed and one flat washer placed beneath each nut.
 - vi. The shims supplied with each pole should be inserted between the pole base and the transformer base to level the pole to a vertical position.
 - vii. Spirit level or surveying instrument should be used.
 - viii. The anchor bolts should then be tightened down with a torque wrench to a torque as specified by the Manufacturer.
 - ix. Specify that Contractor installs and connects ballasts in transformer bases and draws conductors through electrical outlet boxes in poles.

5.2.5 Catenary System

Base the lighting design on an axially suspended catenary system as shown in Plate SP-4-3. In specifying the catenary system, consider the following requirements:

- 5.2.5.1 Specify identical steel poles throughout the Project for suspended catenary system and of sufficient strength to support a suspended cable system as described herein. The system shall be capable of withstanding a wind velocity of 160 km/h and ice loading characteristics of the area and a luminaire dead weight of not less than 9 kg (20 lbs) and a projected area of 0.3 m² (3 sq. ft.)
- 5.2.5.2 Maintain total linear balance by anchoring the terminal poles of each linear section as shown in Plates SP-4-4 & SP-4-5.
- 5.2.5.3 The catenary (upper) and the messenger (lower) cables should be 3/8" nominal diameter.
- 5.2.5.4 The strainer (vertical) and suspension cables should be a minimum 1/8" diameter stainless steel.
- 5.2.5.5 Wind the electrical cable assembly spirally around the messenger cable. Electrical cable shall be XLPE insulated stranded copper conductors in multi cord cable assembly with overall PVC jacket.
- 5.2.5.6 In Medium and Maximum Institutions there are three luminaires in each span of 30 m as shown in Plates SP-4-2 and SP-4-3. The result is a luminaire every 10 m.
- 5.2.5.7 Specify that Contractor installs the catenary system and allows it to follow its natural curve as closely as possible, so that the distance between the catenary and messenger cables will be the minimum at the centre of each span.
- 5.2.5.8 All hardware including turnbuckles, wire rope, clamps, etc., should be hot dipped galvanized steel.
- 5.2.5.9 Each 30 m span of the suspended system should be assembled on the ground then raised and terminated at each consecutive pole. Consult the manufacturer for an application/installation manual for the Catenary Lighting System.
- 5.2.6 Pole Mounted Luminaires and Lamps
 - 5.2.6.1 Specify that luminaires shall be mounted with a tilt angle of 15° around the longitudinal axis.
 - 5.2.6.2 Specify submission of photometric information, based on performance testing by an independent testing laboratory data to be plotted to scale and produced in form in accordance with current I.E.S. and North American practices.
- 5.2.7 Controls
 - Perimeter fence lighting shall be controlled by a photoelectric cell and meet the following requirements:
 - 5.2.7.1 A photo sensitive light control shall automatically turn on the security fence lighting system.
 - 5.2.7.2 The unit should be mounted on an adaptor on a fence lighting pole located in front of the Administration Building.
 - 5.2.7.3 A weatherproof enclosed unit shall be provided which will be unaffected by humidity. It should be capable of operating over a range of -60°C to +55°C.

- 5.2.7.4 The control should prevent the lighting from being energized during the daylight hours but should energize the lamps on a preset (adjustable) value.
- 5.2.7.5 A manual control to turn the lights off when the level of natural light rises to a desired level shall be provided. The manual control must provide control override to turn the lights on for emergency.
- 5.2.7.6 The unit should operate to “fail safe” in the event of failure of any component of the controller. In event of such a failure the lamps should remain energized.
- 5.2.7.7 Design the photo control to be connected in parallel with the “ON” contacts of the “ON OFF” selector switch mounted in a location such as the gatehouse etc., which controls the exterior security lighting system at the institution.
- 5.2.7.8 The photo control shall have a standard NEMA twist lock plug.
- 5.2.7.9 The photocell shall be temperature stabilized pre-aged and hermetically sealed.
- 5.2.7.10 The installation Contractor shall adjust the photo control unit to switch on at not less than 40 lx at 120 volts. The unit should be rated 1000 W incandescent, 120 volts, 60 HZ and CSA approved.

5.3 Other Exterior Lighting

- 5.3.1 Luminaire type
High Pressure Sodium, Metal Halide, Mercury Vapour or Light Emitting Diode (LED) array are the choices for Recreational Areas, Parking Lots, Approach Roads and Collector Lanes. The luminaire must be fully operable between -40°C (or less) and + 50°C (or more).
- 5.3.2 Recreational Areas
 - 5.3.2.1 The recreational illumination system shall be installed on a project specific basis so as to form an integral system as part of the exterior lighting system. Where this is not identified, spare capacity may be provided for future use subject to C.S.C. approval. In general, illumination levels for recreational purposes are approximately 70 lx.
 - 5.3.2.2 Illumination levels for the following recreational activity areas are (Total Area 22,736 m², see Plate 2 for typical layout):
 - a) Softball Diamond - 18 x 18 m overall with 73 m outfield radius, Infield 100 lx, outfield 70 lx.
 - b) Hockey Rink - 60 x 26 m superimposed on softball area where weather permits, 100 lx.
 - c) Running Track – 112 m x 203 m, 50 lx
 - d) Small games as established on a project specific basis; area as required and illuminated to a maximum of 100 lx.
 - e) Dedicated small yards associated with segregated living areas -70 lx.
- 5.3.3 Parking Lots, Institutional Grounds and Approach Roads
 - 5.3.3.1 Average Illumination Levels – 10 lx.

- 5.3.3.2 Light Source – Because of its higher efficiency and longer duration use, LED lighting is preferred followed by high pressure sodium and metal halide as an alternative.
- 5.3.3.3 Illumination Uniformity – Maintain a maximum ratio of average lux to minimum lux of 3:1.
- 5.3.3.4 Illumination Quality – To minimize shadows especially between parked cars illuminate each point from at least two luminaire locations.
- 5.3.4 Controls
 - 5.3.4.1 The recreational lighting controls must be such that the lighting is switched on manually when needed, the controls are located so that security staff can switch off the lights whenever they interfere with their own or the camera's vision.
 - 5.3.4.2 Design other exterior lighting to be controlled by photo cell or astronomical dial time clock with manual bypass feature at a location such as the gatehouse etc. Design to include separate zones for parking lots, for exterior signs and for building periphery.
- 5.3.5 Poles and Masts
 - 5.3.5.1 Specify that all poles and masts used as light standards shall be fabricated from steel conforming to *CSA Standard G40.21-04 (R2009)*⁶ Type T, grade 60T, Low silicon, 60,000 psi yield strength. Do not use concrete poles and masts.
 - 5.3.5.2 Avoid having steps on poles and masts.
 - 5.3.5.3 Minimum height of post for pedestrian walks 3.05 m, for parking lots 6.1 m.
 - 5.3.5.4 The lighting system should incorporate a method by which luminaires on high standards (poles) may be easily and economically maintained.
 - 5.3.5.5 High Standards (30 m poles) are not necessary for Minimum Institution but the pole height should be less than 13 m.

5.4 Maintenance

Develop and specify a plan, and review with User, to ensure that the following will be done at regular intervals:

- 5.4.1 Lamps and luminaries cleaned annually.
- 5.4.2 Lamps replaced immediately when they fail.
- 5.4.3 All lamps replaced, on the basis of a developed group lamp replacement plan, at say 80% of lamp life which should occur every two years. This will ensure that there will be a minimum number of lamp outages during a two year period. With this type of plan the lamps which do burn out are spot replaced as soon as detected and these lamps should be marked and the date of replacement recorded so that at the time of “group relamping” they can be retained for use as future spot replacements.

⁶ CSA G40.20-04/G40.21-04 (R2009) – General Requirements for Rolled or Welded Structural Quality Steel/Structural Quality Steel

- 5.4.4 During the first full year of operation arrange to have the cable system inspected at mid summer and mid winter and adjustments made to provide the proper tension on the suspended cable system.

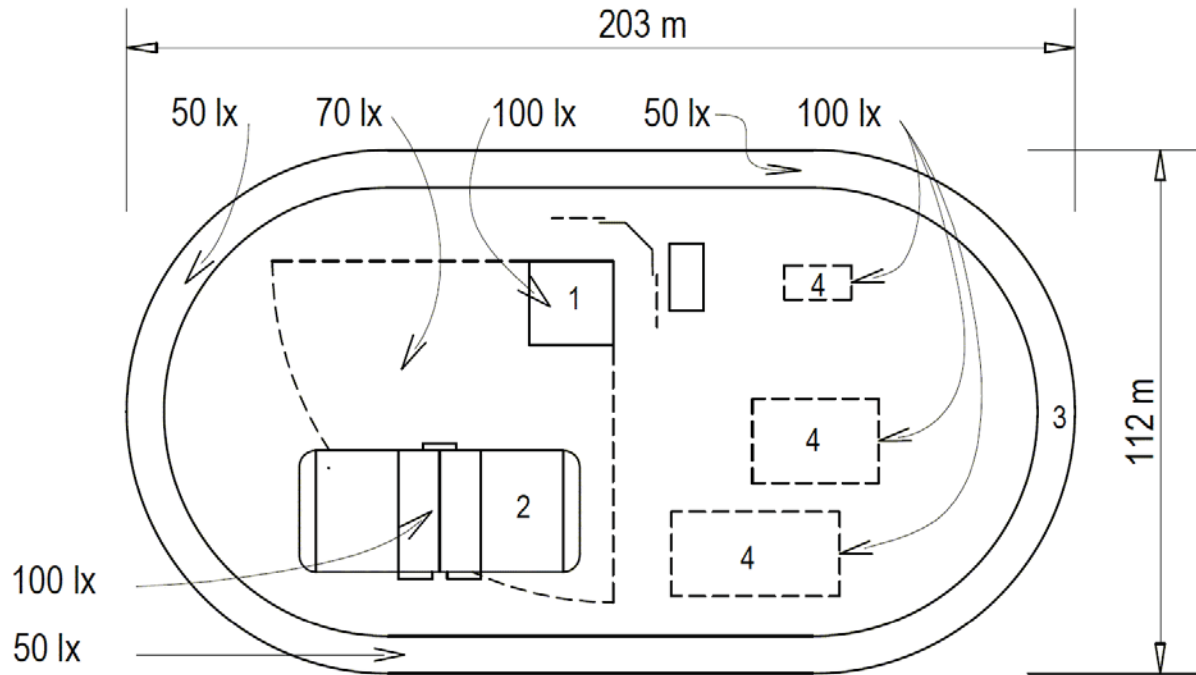

ALLOCATION FOR ILLUMINATION AND LIGHTING LEVELS

1. SOFTBALL DIAMOND 18 X 18 – 73 m OUTFIELD 4 183 m²
(100 lx INFIELD, 70 lx OUTFIELD)
2. ICE HOCKEY RINK 60 X 25 m, 155 m² (100 lx)
3. TRACK LENGTH NON-STANDARD (50 lx)
4. SMALL GAMES – VARIOUS, TOTAL 1 343 m²
APPROXIMATE FIELD SIZE 22 736 m²

SP-4-1 – ATHLETIC FIELD LIGHTING

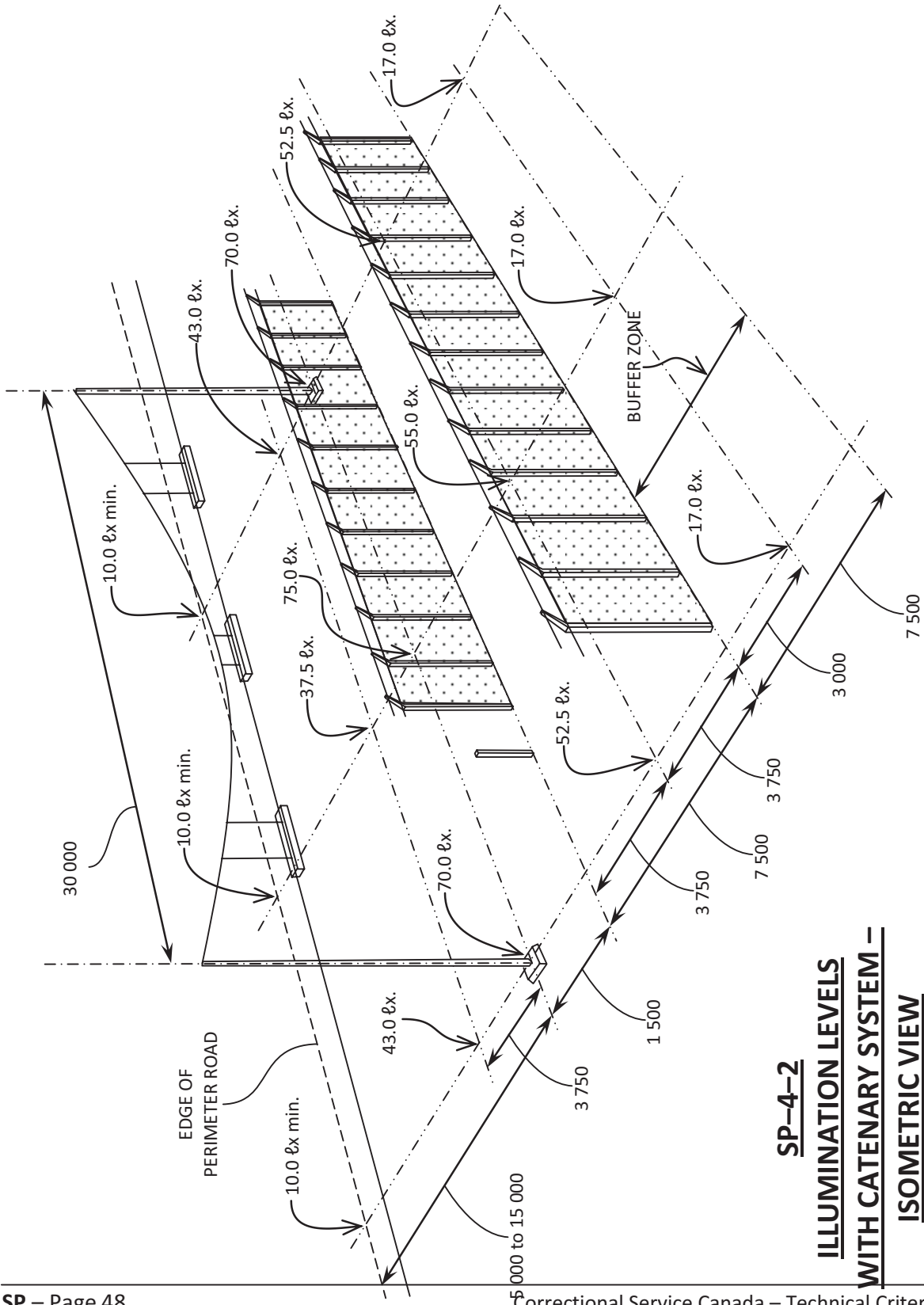

SP-4-2
ILLUMINATION LEVELS
WITH CATENARY SYSTEM -
ISOMETRIC VIEW

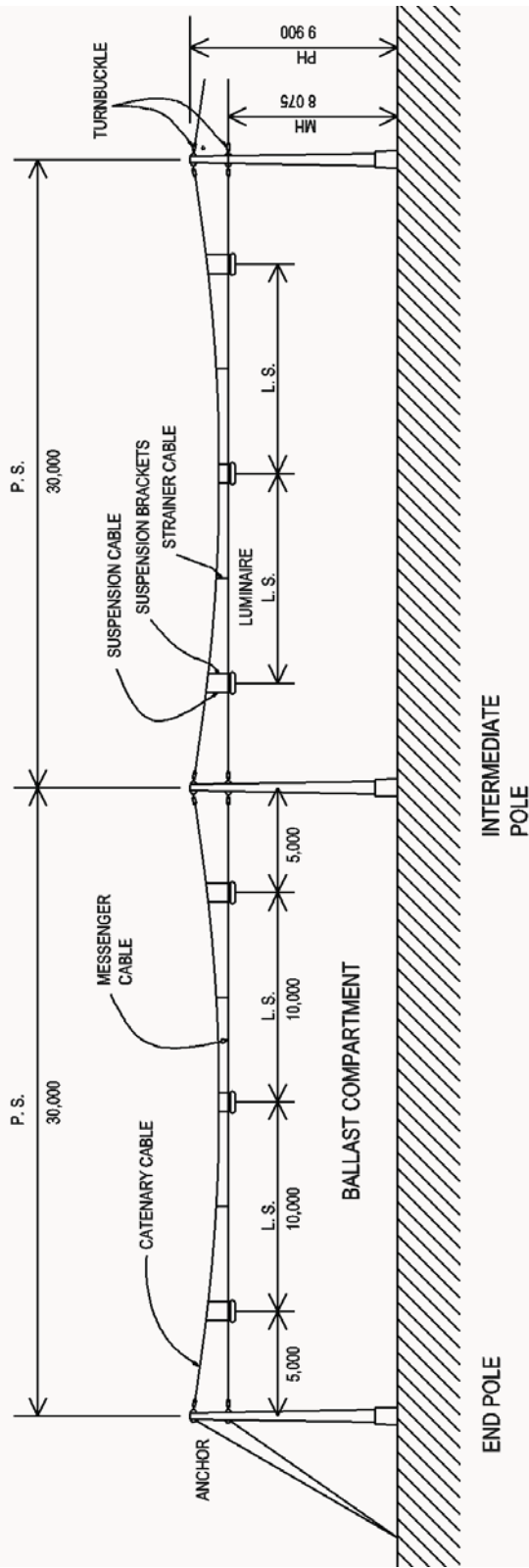

LEGEND

- P. S. - POLE SPACING
- L. S. - LUMINAIRE SPACING
- P. H. - POLE HEIGHT
- M. H. - LUMINAIRE MOUNTING HEIGHT

**SP-4-3 – CATENARY
SYSTEM – SIDE VIEW**

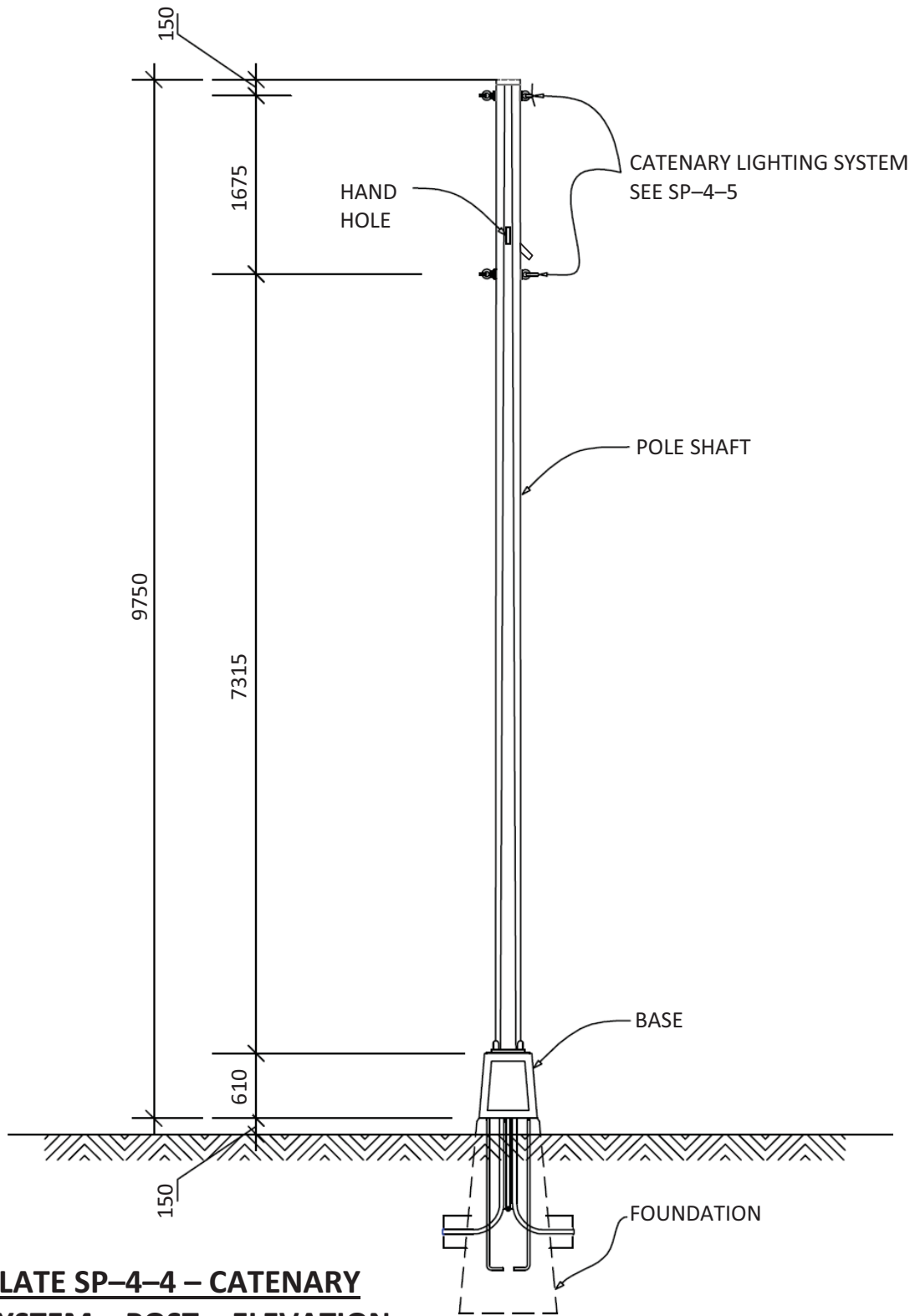

**PLATE SP-4-4 – CATENARY
SYSTEM – POST – ELEVATION**

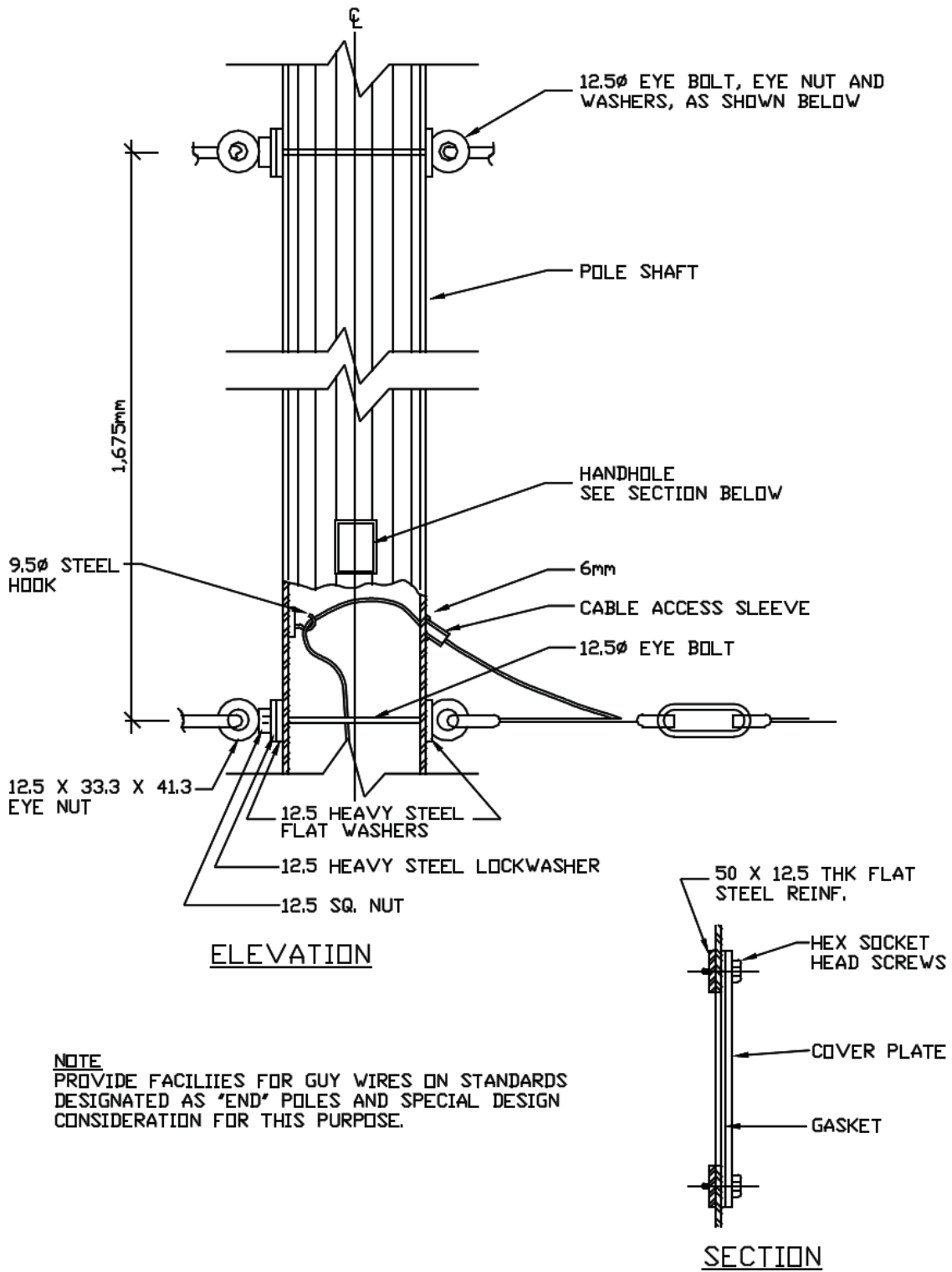

SP-4-5 – CATENARY SYSTEM – POLE DETAIL

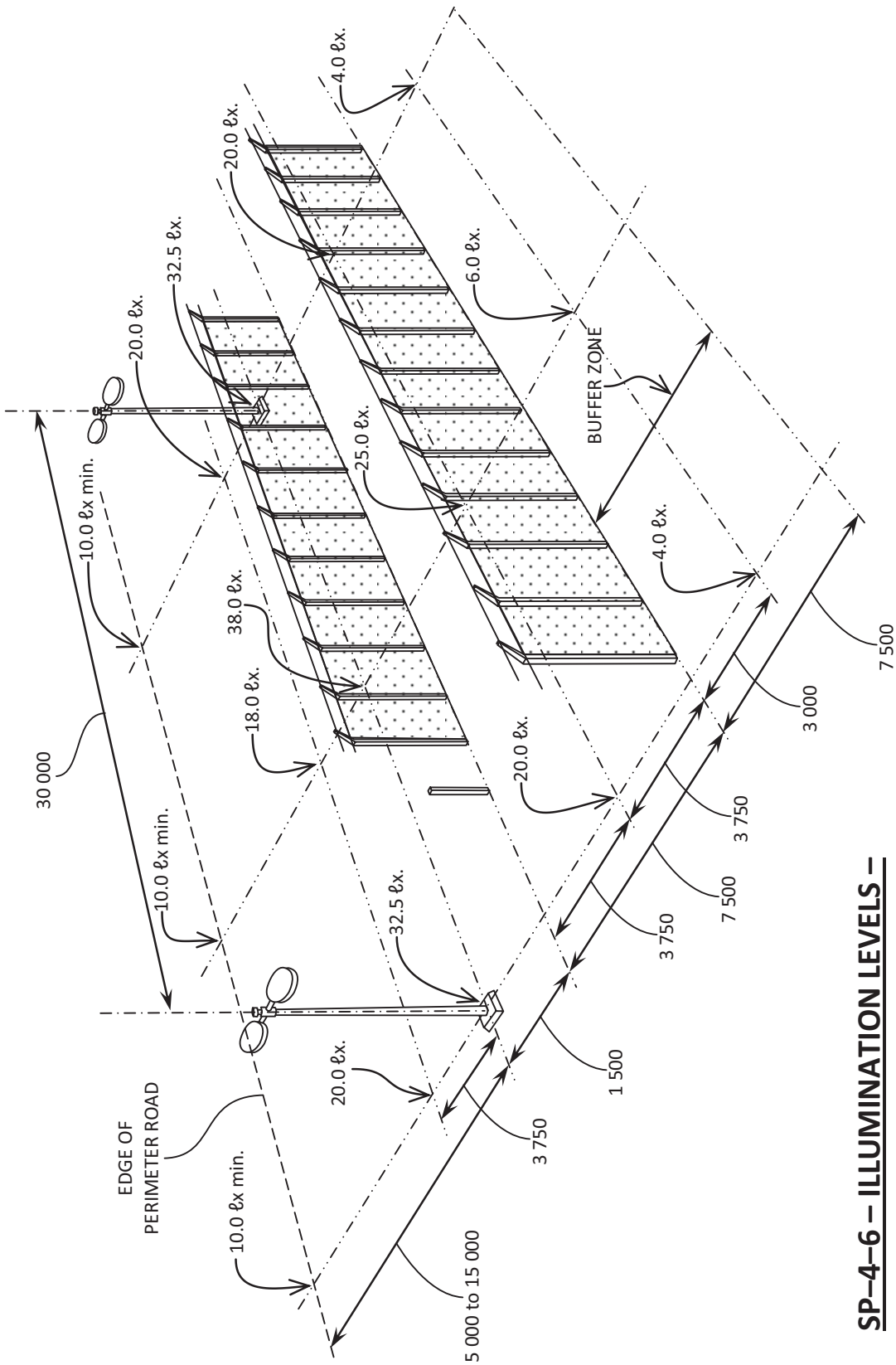

**SP-4-6 – ILLUMINATION LEVELS –
POST MOUNTED LUMINAIRE –
ISOMETRIC VIEW**

SP-5 SITE – TRAFFIC CIRCULATION AND PARKING

1. SCOPE

This section outlines requirements for vehicle and pedestrian circulation and for vehicle parking inside and outside correctional institutions.

2. RELATED SECTIONS

SP-1 – Site Development

SP-2 – Security Fences

ST-1 – Guard Towers

SP-3 – Gates/Sallyports

SP-4 – Lighting

3. CIRCULATION SECURITY REQUIREMENTS

3.1 *Outside the Institutional Perimeter*

- 3.1.1 For ease of control, there shall be only one roadway providing access to the institution from a public thoroughfare.
- 3.1.2 All parking, including that of staff, visitor and CSC owned vehicles, shall be located on the exterior of the institution and in proximity to the Principal Entrance.
- 3.1.3 A dedicated perimeter patrol road shall be provided which will allow a rapid patrol vehicle response and which will have a minimum number of crossings; this road shall also be used for access into the institution via the Emergency Vehicle Entrance as well as for the use of maintenance vehicles servicing perimeter lighting, fences, and cameras, when required.
- 3.1.4 Pedestrian walks shall only be provided from the parking area to the Principal Entrance.

3.2 *Inside the Institutional Perimeter*

- 3.2.1 A pedestrian circulation network shall connect all buildings. At the Maximum security level, the network may be fenced, covered or enclosed (unheated) for movement control. Consideration of enclosed networks must be based on security requirements only; they are not intended to provide shelter from the elements for pedestrian movements from one activity area to another.
- 3.2.2 Fire vehicle access shall be in accordance with applicable authorities. Two different access routes, one to the Principal Entrance, one to the Emergency Vehicle Entrance shall be provided with clear signage (see SP-3:3.2).
- 3.2.3 Vehicle roadways are required for service functions and shops. Every effort shall be made to ensure that these do not interfere with inmate movement and that they are located away from outdoor inmate activity areas.

- 3.2.4 Vehicle loading and unloading zones shall be centralized where possible, or located in proximity to one another to facilitate their control. The loading zones shall be located away from inmate movement and exterior activity areas, and shall be close to the Principal Entrance or Service Entrance where applicable.

4. DESIGN REQUIREMENTS

4.1 *Roadways (Other than Perimeter Patrol Road)*

- 4.1.1 The access road shall be integrated into the public road system; it shall not provide hazardous crossings nor cause undue congestion during peak hour movements.
- 4.1.2 All roads shall be asphalt paved unless local conditions dictate otherwise.
- 4.1.3 The minimum widths of paved surfaces shall be as follows:
- One way single lane: 3.5 m
 - Infrequently used access ways: 4.8 m
 - Two way double lane: 7.0 m
- 4.1.4 Roadway curbs shall not be used.
- 4.1.5 Drainage, turning radii, prepared shoulders and intersections shall conform to local municipal standards.
- 4.1.6 Pedestrians and vehicles shall share the same traffic surfaces except as provided for above.
- 4.1.7 Roadways shall be illuminated as per section SP-4 Site Lighting.

4.2 *Perimeter Patrol Road*

- 4.2.1 The perimeter patrol road shall encircle the complete perimeter at a distance of 8 m (minimum) to 20 m (maximum) from the face of the Outer Perimeter Fence to the centre line of the road.
- 4.2.2 The paved width of the patrol road shall be 4.8 m, with a prepared shoulder of 1 m on each side.
- 4.2.3 The patrol road surface elevation shall not be lower than the ground elevation between the perimeter security fences.
- 4.2.4 The area between the patrol road and the perimeter fence shall be clear of all obstructions, except for guard towers where applicable.
- 4.2.5 The roadway shall be generally straight; curves shall be mild and sufficiently banked to permit moderately high speeds. Optimal response time for a patrol vehicle to travel one half of the perimeter circumference is 30 seconds by one of two vehicles. Patrol road system should allow for a maximum response time of 45 seconds.
- 4.2.6 The patrol road shall have turn-arounds on each side of the institution as well as at each corner of the perimeter fence. Generally, turn-arounds are provided at approximately 150-m intervals. See Plates SP-2-4, SP-2-5 and SP-5-1. All turn-

around shall be paved and sized to allow for a vehicle to turn a full circle. Vehicle turning radius shall be assumed to be 7.5 m.

- 4.2.7 The patrol road when used for truck movement to construction sites via dedicated access points other than the principle entrance shall be widened at the location of the entrance gates in order to facilitate vehicles turns and to not obstruct patrol vehicle movement as trucks await access.
- 4.2.8 Drainage for the patrol road shall consist of flanking shallow and broad swales to permit vehicle access onto the terrain on either side of the road. Maximum slope for the swale shall be 25% (1:4), to a maximum depth of 600 mm (Plate SP-5-2). The minimum grade cross-slope of the paved surface shall be 2% ¹. See Plate SP-1-2 for a perimeter fences and patrol road general layout and SP-1-3 for a cross-section detail of the road.
- 4.2.9 Culverts over 350 mm in diameter shall be provided with grilles to prevent their use as hiding places by inmates. Clear grille openings in any one direction shall not exceed 125 mm by 610 mm in the other direction (see details in M-4: 8.2).
- 4.2.10 Illumination of the patrol road shall be satisfied by perimeter fence lighting as per Section SP-4 Site Lighting.

4.3 Pedestrian Walkways

- 4.3.1 Walkways shall be of monolithic material such as asphalt or concrete. Small or thin pavers which can be lifted or broken shall not be used.
- 4.3.2 Walkway design shall allow for movement of handicapped persons and snow removal equipment s well as forecasted traffic volume.

4.4 Parking (Other than for CSC Vehicles)

- 4.4.1 Inmate visitor parking and staff parking shall be separately demarcated. Inmate visitor parking stalls shall be provided at a ratio of 50% of the maximum number of inmates allowed in the visits area at one time (visit capacity); such visit capacity shall be identified on a project specific basis.
- 4.4.2 The number of staff parking stalls shall be provided at the rate of 1.2 multiplied by the peak weekday shift; this staff complement shall be identified on a project specific basis. The staff parking lot shall also accommodate the cars of official visitors.
- 4.4.3 Parking areas shall be asphalt paved unless local conditions dictate otherwise.
- 4.4.4 Curbs shall not be used, although pre-cast wheel stops are permitted.
- 4.4.5 Landscape islands and trees are permitted but dense planting shall be avoided.
- 4.4.6 Parking stall dimensions (including those for handicapped persons) and drainage provisions shall conform to local municipal standards.

¹ American Association of State Highway and Transportation Officials (AASHTO), A Policy on Geometric Design of Highways and Streets, 5th Edition, 2004 – AASHTO GD-2 A Policy on Geometric Design of Rural Highways, 1965 – Transport Association of Canada also refers to this document

4.4.7 Parking areas shall be illuminated as per section SP-4 Site Lighting.

4.5 Parking for CSC Vehicles

4.5.1 A CSC vehicle parking compound shall be provided, located on the outside of the perimeter fence; size shall be defined on a project specific basis.

4.5.2 The parking compound shall be located in proximity to the Principal Entrance and the perimeter patrol road for ease of periodic surveillance.

4.5.3 The parking compound shall house fuel dispensing pumps and tanks. The compound shall be protected by bollards and 2.5m high fence.

4.5.4 Fuel shall be stored in registered tanks in accordance with the Storage Tank Systems for Petroleum Products & Allied Petroleum Products Regulations². The fuel storage tanks (preferably aboveground) will be located adjacent to the fuel pumps and the distribution lines shall also be aboveground, where feasible.

4.5.5 The parking compound shall be illuminated as per section SP-4 Site Lighting.

4.6 Electrical Outlets for Engine Blocks

Institutions are often located in isolated areas in climate zones having sustained low temperatures, frequently -20°C or less. In such situations, a decision to determine whether electrical outlets for engine blocks are required is based on the following:

4.6.1 CSC Vehicles

CSC institutions, by their very nature, situation, and role, differ from other government installations. The intent is that institutions have a ready to run CSC vehicles for everyday operations including escort or transfer of inmates. Consequently, electrical outlets for block heaters are mandatory.

4.6.2 Staff Vehicles

The provision of outlets must be consistent with local practices. For this, a survey of other Government buildings and local area business and plants will determine the need to provide electrical outlets for block heaters.

4.6.3 Other Vehicles

Electrical outlets for block heater shall not be provided for visitor parking or for other short use vehicles.

4.6.4 Parking Electrical Outlets General Requirements

For CSC staff who work a regular schedule, electrical outlets may be controlled by timer or by a programmable controller.

Electrical outlets design and installations shall be in accordance with the Canadian Electrical Code and any local or municipal by-law.

² Tank Systems for Petroleum Products & Allied Petroleum Products Regulations (SOR/2008-197). Regulation under the Department of Justice Canada.
<http://laws.justice.gc.ca/eng/SOR-2008-197/index.html>

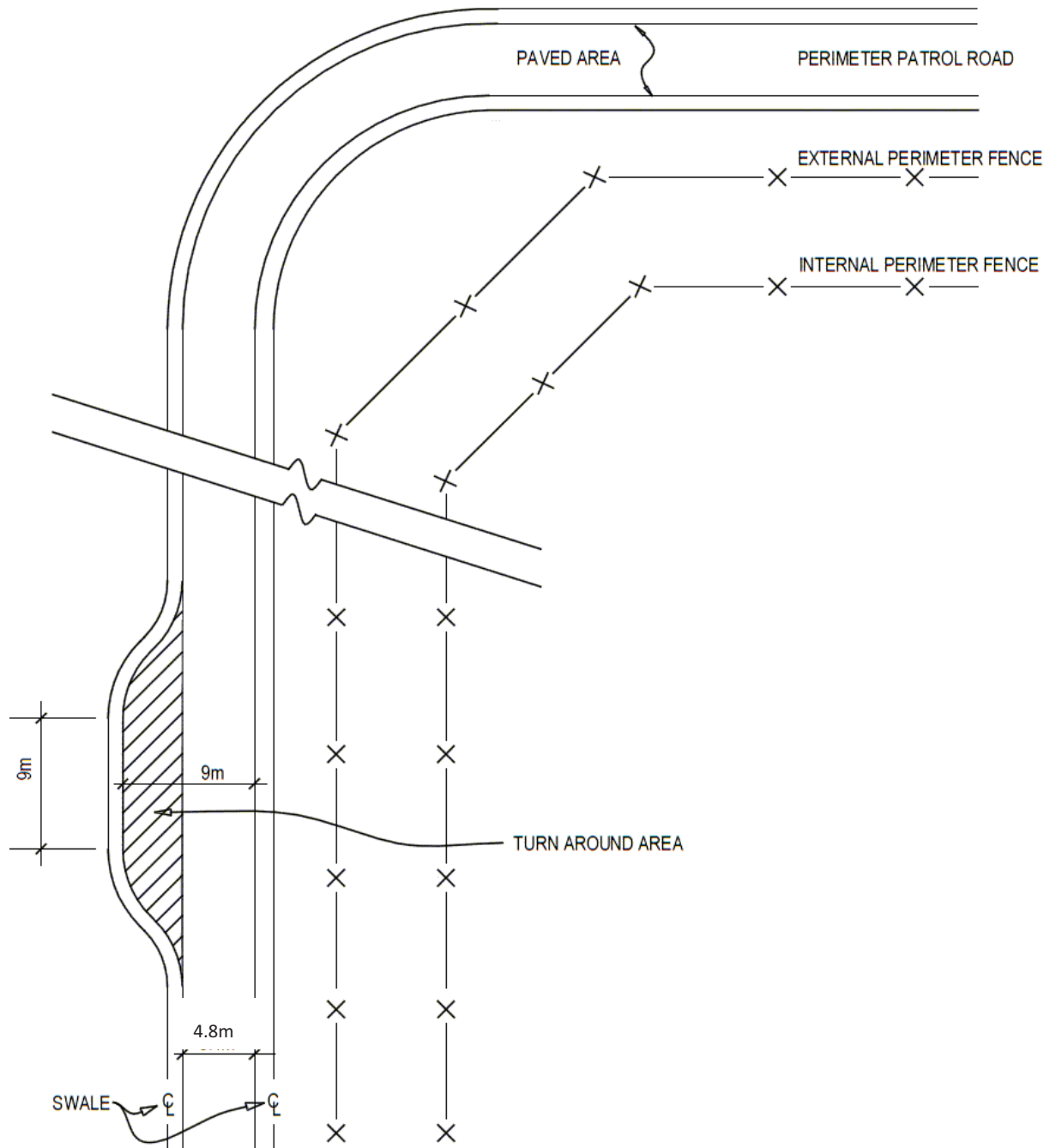

PLATE SP-5-1 – OPTIONS FOR TURN-AROUND

SP-6 SITE – TEMPORARY CONSTRUCTION FENCES

1. SCOPE AND DEFENITIONS

This section provides performance criteria and relevant specifications for all temporary construction fences for minimum, medium, maximum and multi-level Institutions.

Several options for temporary fences are available. Their selection must weigh the following factors: location of construction, the risk of breach, and the duration of construction. Fence types include:

Type 1 Minimum institution construction fence is used primarily as a physical barrier to prevent unauthorized persons access to the site for reasons of safety and to protect the contractor's assets. This fence is no different than what may be used in any community.

Type 2 Fences in restricted and highly controlled inmate areas such as where routine vehicle movement takes place for deliveries at medium and higher level institutions and therefore the likelihood of breach is minimal. The fence here also serves to prevent unauthorized person access for similar reasons as above. This fence too is no different than what may be used in the community. Construction truck traffic is via the main entrance vehicle sallyport where it is inspected for contraband. Type 2 Fence shall also be used where construction duration is short term as for a repair or replacement of existing systems or the work site shifts by phase from building to building. The institution in this case will schedule inmate movement and activities so as to mitigate risk of breach. Truck traffic to the site will be escorted from the main entrance. Type 2 fence may be used as an alternative to Type 3 assuring adequate security where required by being topped with BTC.

Type 3 Fences in inmate movement and activity areas at medium and higher level institutions and where breach is possible. Construction truck traffic is via the main entrance vehicle sallyport where it is inspected for contraband. Trucks are escorted to the construction site. This fence is used for long term projects which have a substantial scope and cost. Fences here must assure appropriate security based on assessed risk.

Type 4 For long term projects which are in proximity to the perimeter fence, a secured fence compound shall be constructed which is integrated with the perimeter effectively forming an extension of the inner perimeter fence. This fence will be fitted with a Fence detection system and covered by camera and lighting integrated with the PIDS. A dedicated sallyport will be constructed on the perimeter fence line for construction truck traffic to be controlled by contracted commissionaires.

2. RELATED SECTIONS

2.1 *Technical Criteria Document sections:*

- SP-1 - Site Development
- SP-2 - Fences
- SP-3 - Gates/Sallyports
- SP-4 - Site Lighting
- SP-5 - Traffic Circulation and Parking

2.2 *Other CSC document*

Statement of Technical Requirements – Temporary Construction Fences at Medium and Maximum Security Institutions, Correctional Service Canada, Technical Services Branch – Electronic Systems, Issue 3, April 8, 2011.

2.3 National Master Specification section:

01 35 13 – Security Requirements (prior to 2004: 01003 – Security Requirements)

01 56 26 – Temporary Fencing

01 56 36 – Temporary Security Enclosures

3. PERFORMANCE CRITERIA**3.1 Type 1 Fence**

This fence type shall be a self supporting welded mesh sectional fence typically available by rental ('Modu-loc' or similar). The height of the fence shall be no less than 1800 mm high but may be higher depending on local availability. The fence must be stable and self supporting. Welded wire mesh is considered to be non-climbable due to its mesh size which inhibits the insertion of toes to aid climbing. The top of the fence also has the vertical wire projecting up discouraging breach. Matching vehicle gates are padlocked after work hours. The temporary construction fence shall be removed from the institution by the contractor after construction is completed.

3.2 Type 2 Fence

This fence type shall be similar to the above but with a height of 2400 mm. This fence must not come in contact with the perimeter fence nor be closer than 12m to the perimeter fence so as not to interfere with PIDS camera viewing on the interior side of the institution. The temporary construction fence shall be removed from the institution by the contractor after construction is completed. Type 2 fence security can be enhanced by topping it with BTC. This alternative to Type 3 fence shall be considered as a measure to reduce cost of the project.

3.3 Type 3 Fence

This fence type shall be similar to a standard woven mesh interior fence, be 3.6m high and, be topped with BTC where required. This fence shall be installed on site with all posts set in concrete and the ground surfaced with compacted gravel. Matching swing type vehicle gates shall be padlock after hours. As for type 2 fence, this fence must not come in contact with the perimeter fence nor be closer than 12m. Truck access to this compound shall be via the Main entrance with all vehicles escorted. The temporary construction fence shall be dismantled by the contractor after construction is completed but parts such as the fabric may be left at the institution in accordance with the contract documents.

3.4 Type 4 Fence

This type of fence forms part of the perimeter and as such requires special provisions as follows:

3.4.1 This is a single fence of the same design as an Inner Perimeter Fence (see Plate SP-6-6) and conforms to Chapter SP-2 - Fences, performance criteria 4.1 except for anti-tunnelling which is achieved by compacted gravel surface for 1m distance on each side of the fence.

3.4.2 A Fence Detection System (FDS) is required and connected to the Main Communication Control Post (MCCP).

3.4.3 Cameras are required to monitor the fence line and connected to the MCCP and lighting may be required to enhance viewing.

3.4.4 A dedicated vehicular entrance is required similar to the main entrance sallyport comprising three (3) gates (see Plate Sp-6-7, Detail 1):

- a) Gate 1: Temporary gate for the outer perimeter fence,
- b) Gate 2: Temporary gate for the inner perimeter fence,
- c) Gate 3: Temporary gate in a temporary fence to form a vehicle sallyport.

At any time, at least two gates of the temporary vehicular sallyport are secured, with padlocks and keys under the control of a Commissionaire. A commissionaire's temporary hut is required within the sallyport.

- 3.4.5 The fence must be clear of any building by 12 m but a shorter clearance may be considered since the compound is always protected by a double fence between it and the exterior of the institution.
- 3.4.6 The fence and systems must be dismantled and handed to the institution in accordance with the contract documents after the construction is completed. All systems must be reinstated to the original state and function.

4 RELEVANT SPECIFICATIONS

4.1 *Type 1 Fence*

Rental construction protection fence comes with welded wire mesh and components conforming to ASTM F2919 Welded Mesh Fence specification. Mesh is galvanized steel no larger than 50X150mm (vertically long rectangle) with vertical wire projecting and exposed at top. Fence must be at least 1800mm high and secured with pins inserted in the ground through the 'T' base support. Sections of fence must be securely clamped together to ensure that the each fence run acts as a continuous barrier which will resist lateral forces and separation. Sloped runs must be protected by mesh panels to ensure continuity of barrier from ground up.

4.2 *Type 2 Fence*

This fence is similar to Type 1 above but shall be 2400mm high. Ground along the fence run shall be surfaced with compacted gravel. 'Barbed tape concertina' (BTC) where required and used as an alternative to Type 3 fence shall be as per SP-2-4.2 except that it could be directly attached with galvanized twist ties or clips to the top rail or wire resting against the mesh on the threat side. Use of steel arms fastened to the posts may also be considered for the support of 2 barbed wires and BTC.

4.3 *Type 3 Fence*

This fence conforms to the criteria set out in SP-2 for perimeter fences. It shall be topped by steel arms supporting 2 strands of barbed wire and BTC. The arms shall have 2 strands of barbed wire with the BTC cradled between. Steel arms lean towards the threat side.

4.4 *Type 4 Fence*

The following pertains to a single fence extension of the inner perimeter fence:

- 4.4.1 This fence is a continuous connected to the inner perimeter fence at each end. It shall conform to the specification for an interior fence as in "Chapter SP-2 – Fences, Conforming Specifications 4.1.8 and 4.2." and relevant plates; only exception being that the BTC needs to be installed only on the threat side at the first intersecting panel.
- 4.4.2 The three temporary construction gates must conform to "Chapter SP-3 - Gates and Sallyport, 5. – Fence Gates, 5.2 Vehicle Swing gates". Gate 2 (the gate on the Inner Perimeter Fence) requires FDS that can be masked during construction

hours and unmasked for all other times. The gate FDS must connect to the MCCP.

- 4.4.3 Motion Detection System (MDS) cable exists within the No Man Zone between the fences. This cable has to be protected from heavy trucks and machinery at the crossing by installing an asphalt pad of 150 mm thick without disturbing the gravel surface over the MDS cables (see Plate SP-6-7). This material can be removed following construction. It is also important to limit the use of salt during winter months. Excess salt will drain to the sides and seep into the surrounding surface adversely effecting the MDS cable's RF field.
- 4.4.4 A temporary microwave system covers the vehicle crossing area within the No Man Zone.
- 4.4.5 Temporary gates may be installed between the perimeter fences at the sallyport crossing to allow maintenance vehicles to circulate, these gates must be designed to not interfere with both the MDS and the temporary microwave systems.

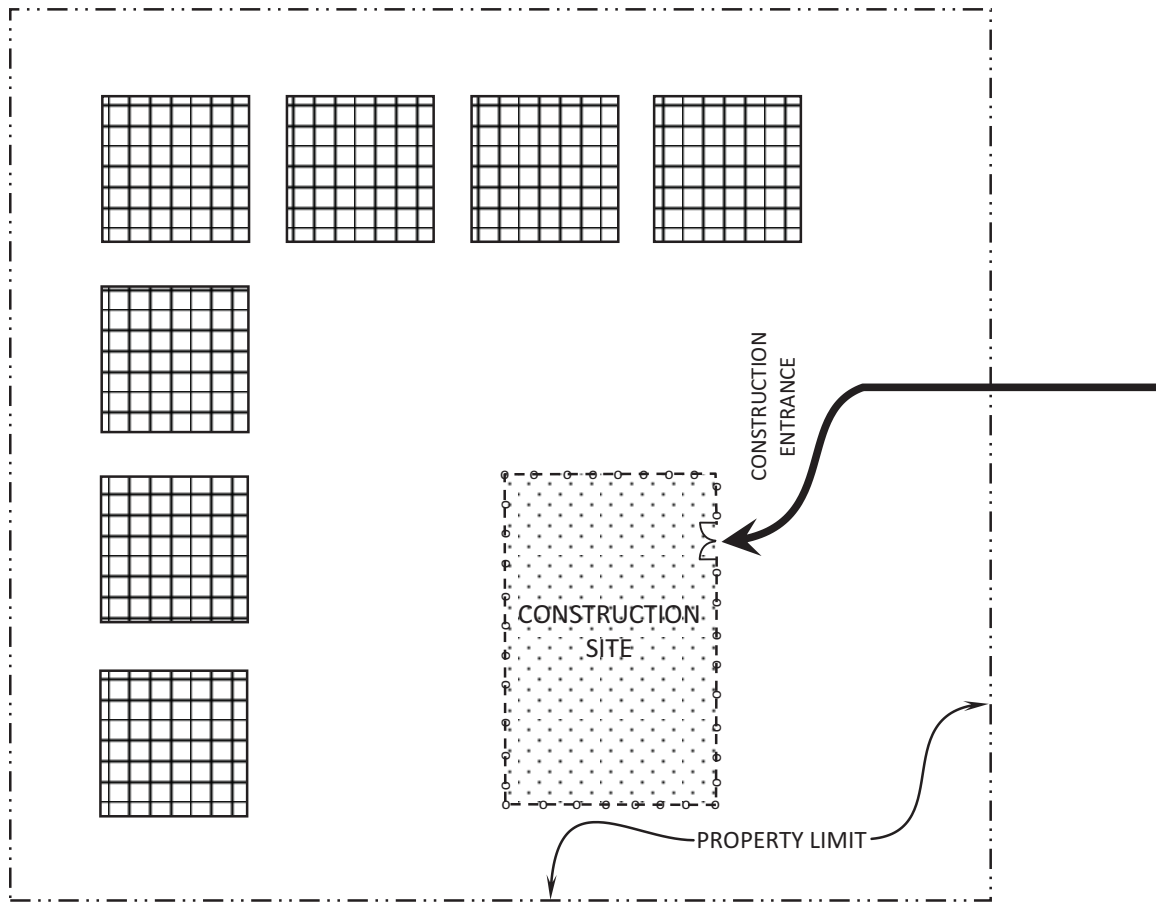

PLATE SP-6-1 – TYPE 1 FENCE

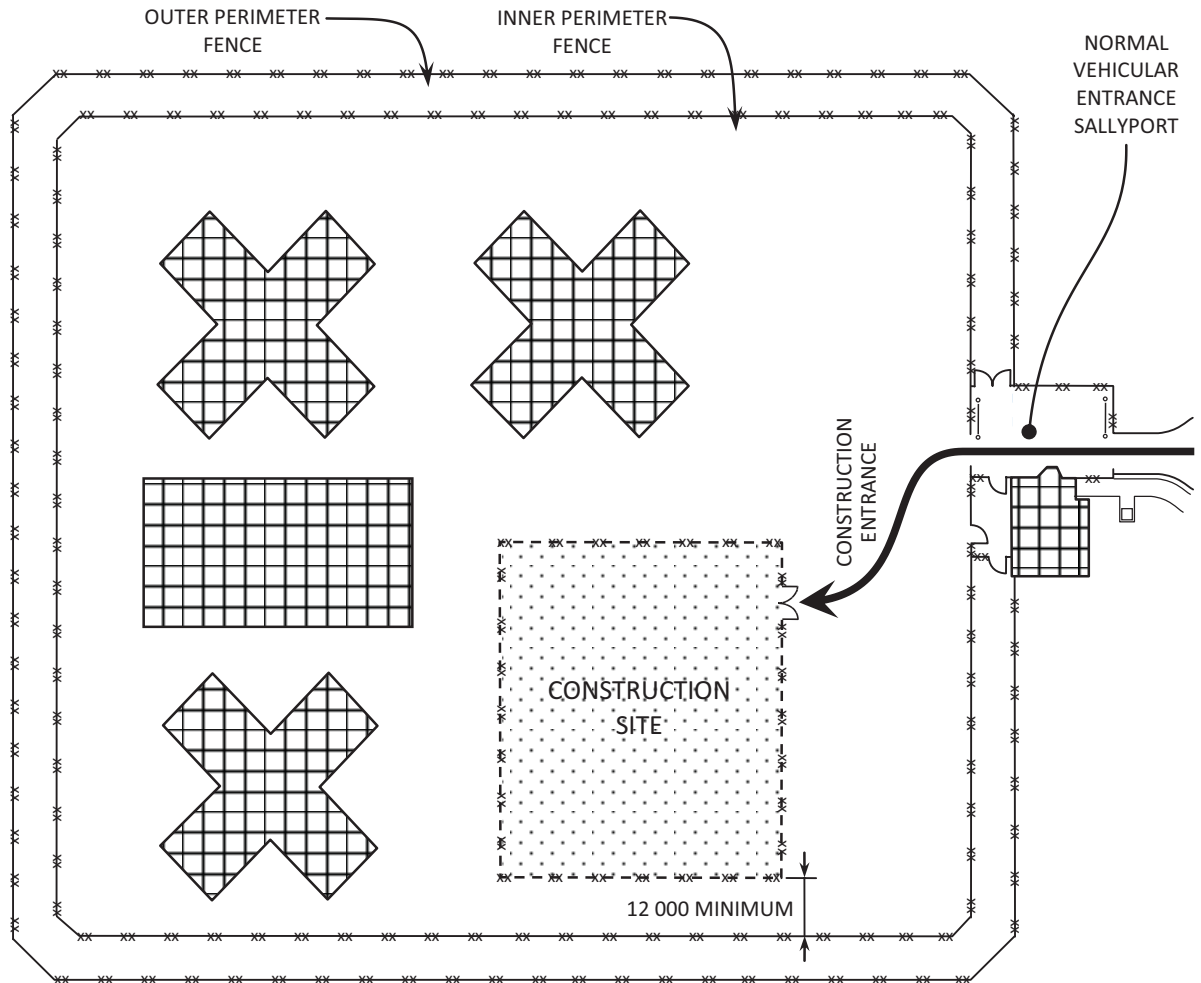
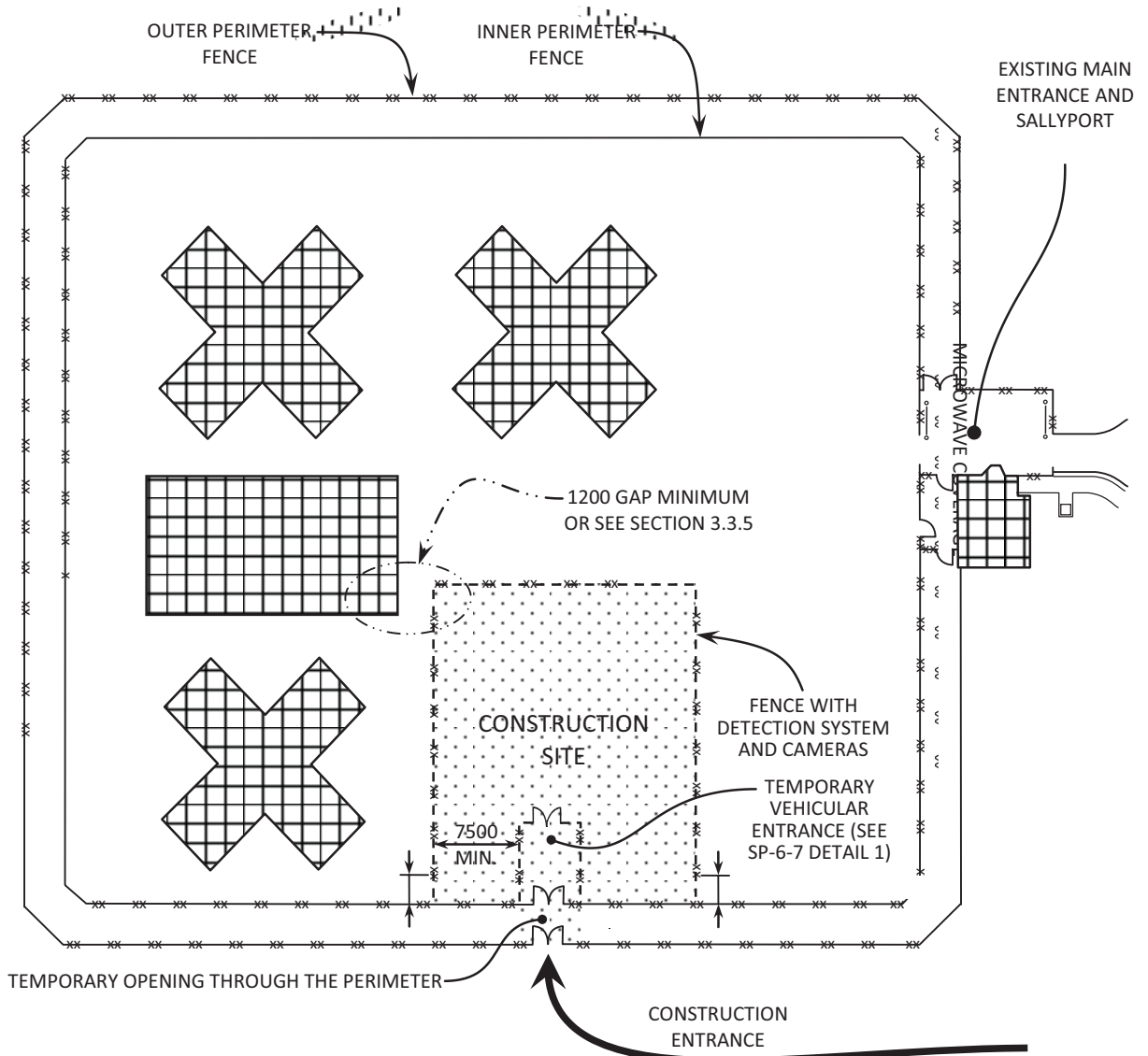
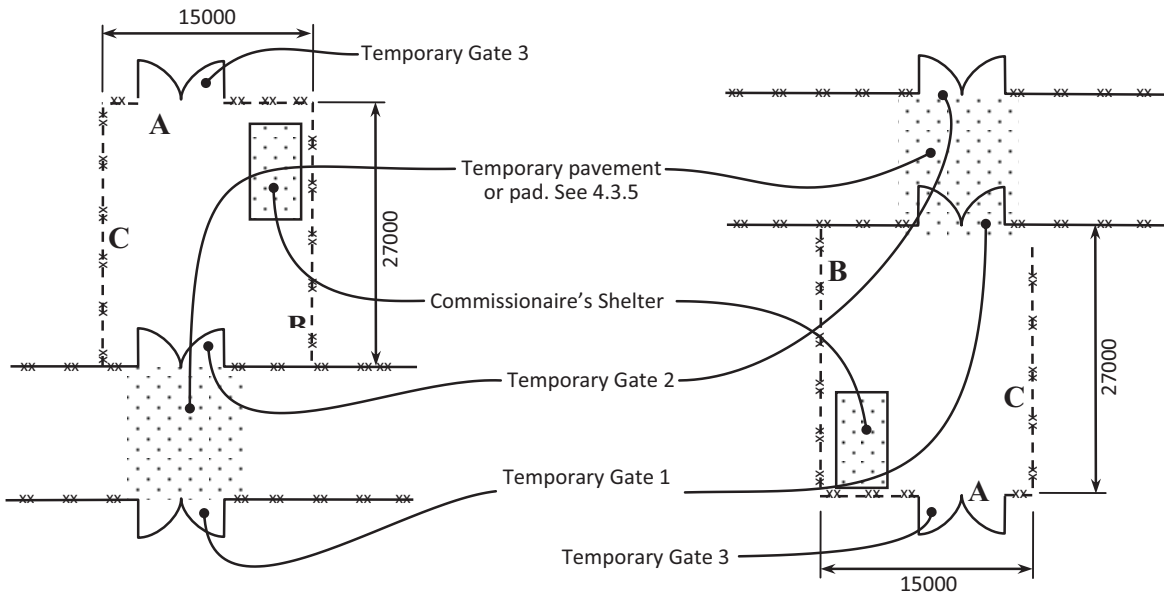

PLATE SP-6-2 – TYPE 2 AND 3 FENCE

PLATE SP-6-3 – TYPE 4 FENCE





A – INSIDE THE INSTITUTION

B – OUTSIDE THE INSTITUTION

SP-6-4 – TYPE 4 FENCE –
ENTRANCE OPTIONS

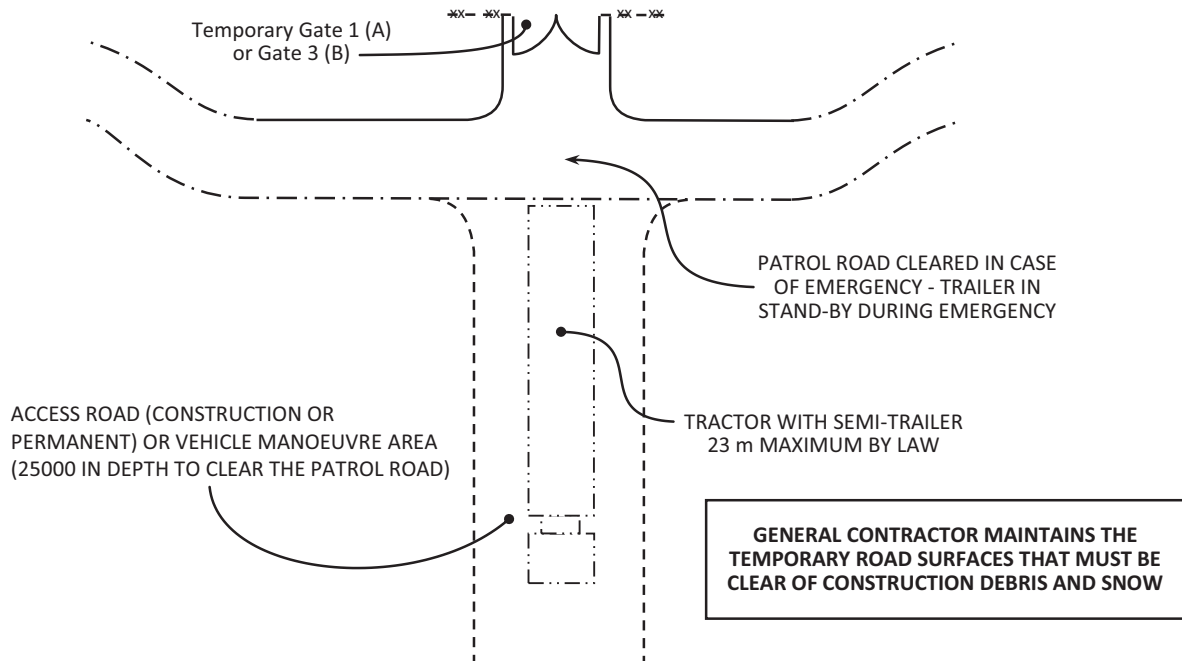

SP-6-5 – TYPE 4 FENCES –
VEHICLE ACCESS DETAIL



1 DOCUMENTS REVIEWED

- 1.1 Digital copy of Plans and Specifications received by e-mail on December 2nd, 2014.

2 OVERVIEW

- 2.1 This is a technical review of the project only and is generic in nature. This review is undertaken in accordance with;
- .1 Federal Government Standards and Policies.
 - .2 Best Design Practices.
 - .3 Professional Architectural and Engineering Industry Standards for Contract Documentation.
- 2.2 This review in no way alleviates the Consultants from their professional and contractual responsibilities for:
- .1 Code Compliance.
 - .2 Validation of design.
 - .3 Quality of construction documentation.
 - .4 Adherence to current Standards, CGSB, CSA, etc.
 - .5 Full co-ordination between disciplines.
 - .6 Providing all aspects of the required scope of work.
 - .7 Ensuring that all operational requirements and functional needs are properly accommodated in the final design.
 - .8 Application of Federal Government Sustainable Development practices.
 - .9 Risk Management Planning
 - .10 Value Engineering / Life Cycle costing analysis of major building components
- 2.3 A written response is required in the space provided adjacent to each comment in this review.



PWGSC COMMENTS	CONSULTANTS RESPONSE
<p>3 UNIT PRICE TABLE 3.1 No Estimated Quantities provided for the various units of measurement.</p>	<p>Unit price table has been removed.</p>
<p>4 TABLE OF CONTENTS 4.1 Add list of Drawings to the Table of Contents. 4.2 The CSC Technical Specifications referred to in several Sections should be added as an Appendix to the Specifications.</p>	<p>Drawing list added to TOC. CSC Tech Specs added as an Appendix.</p>
<p>5 SPECIFICATIONS 5.1 General Comments .1 Remove "Unit Price Table". Project is to be bid as a complete project. 5.2 Division 01 General Requirements .1 Section 01 00 10 General Instructions .1 Replace "Consultant" with "Departmental Representative". Use of "Consultant" is not relevant anywhere in the specifications. Review the GP&S document and discuss with the Departmental Representative. The Departmental Representative is the contractual entity. .2 Article 1.7.3 – replace "five working days" with "two working days" .2 Section 01 14 00 Work Restrictions .1 Replace "Consultant" with "Departmental Representative". Use of "Consultant" is not relevant anywhere in the specifications. Review the GP&S document and discuss with the Departmental Representative. .3 Section 01 33 10 Submittal Procedures .1 Replace "Consultant" with "Departmental Representative". Use of "Consultant" is not relevant anywhere in the specifications. Review the GP&S document and discuss with the Departmental Representative. .2 Article 1.1.3 – add "and approved" to end</p>	<p>Unit price table has been removed. Replaced. Replaced. Replaced. Replaced. Added.</p>



PWGSC COMMENTS	CONSULTANTS RESPONSE
<p>of sentence.</p> <ul style="list-style-type: none"> .4 Section 01 47 19 Sustainable Requirements <ul style="list-style-type: none"> .1 Article 1.3.2.3 – Remove “Consultant”. .5 Section 01 52 00 Construction Facilities <ul style="list-style-type: none"> .1 Article 1.7 - Construction items left onsite overnight/thru the weekend or through Holidays, must be in the Construction Laydown area approved by the Client and Departmental Representative and must be locked by the Contractor with the key kept by the Commissionaires for the duration of the project. <p>5.3 Division 31 Earthwork</p> <ul style="list-style-type: none"> .1 Section 31 23 33.01 Excavating, Trenching & Backfilling <ul style="list-style-type: none"> .1 Sub-section 1.2 Definitions <ul style="list-style-type: none"> .1 Article .1.1 – rock size of 0.50m³ seems small, usually its 1.00m³. <p>5.4 Division 32 Exterior Improvements</p> <ul style="list-style-type: none"> .1 Section 32 31 13 Chain Link Fences and Gate <ul style="list-style-type: none"> .1 Sub-section 1 General <ul style="list-style-type: none"> .1 Missing a Measurement for Payment article which explains how the work is paid for. 	<p>Removed.</p> <p>Article 1.7 Revised to match.</p> <p>0.50m³ equates to 800x800x800mm. The difference is small. Contractor takes risk of soil/rock quantity.</p> <p>Measure of payment not required. Fixed price bid.</p>
<p>6 DRAWINGS</p> <p>6.1 Civil</p> <ul style="list-style-type: none"> .1 Drawing D-C01 General Notes <ul style="list-style-type: none"> .1 No Comment. .2 Drawing D-C02 Project Notes Sheet 1 Current Year <ul style="list-style-type: none"> .1 No comment. .3 Drawing D-C03 Project Notes Sheet 2 Current Year <ul style="list-style-type: none"> .1 No comment. .4 Drawing D-C04 Project Notes Sheet 3 Current Year Plus One <ul style="list-style-type: none"> .1 Note 12 – New anti-tunnelling wall – The Detail 1/D-C10 provides very little detail on this wall i.e. is there any wire mesh/reinforcing required for the wall? 	<p>To be picked up by addendum.</p>



PWGSC COMMENTS	CONSULTANTS RESPONSE
<p>Between the posts does the wall extend from the ground line to a minimum depth of 2135mm? What kind of concrete mix goes into this wall, what minimum strength requirements, etc?</p> <p>.5 Drawing D-C05 Overall Site Plan .1 No comment.</p> <p>.6 Drawing D-C06 Site Plan NE Quadrant .1 No comment.</p> <p>.7 Drawing D-C07 Site Plan SE Quadrant .1 No comment.</p> <p>.8 Drawing D-C08 Site Plan –NW Quadrant .1 No comment.</p> <p>.9 Drawing D-C09 Site Plan – SW Quadrant .1 No comment.</p> <p>.10 Drawing D-C10 Details Sheet 1 .1 No comment.</p> <p>.11 Drawing D-C11 Details Sheet 2 .1 Detail 3 – Angle of the Control arm to the horizon – is it specified somewhere, if not suggest note angle = 45⁰ or whatever Consultant intends.</p> <p>.12 Drawing D-C12 Details Sheet 3 .1 Detail 6 – how deep is the re-used existing fence post to be embedded? Detail 2/D-C10 shows 1650mm min, but in this detail the bent plate is shown embedded 1650mm and the steel post is shown at an unknown depth.</p> <p>.13 Drawing D-C13 Details Sheet 4 .1 No Comment.</p> <p>.14 Drawing D-C14 Details Sheet 5 .1 No Comment.</p>	<p>To be picked up by addendum.</p> <p>To be picked up by addendum.</p>



Quality Assurance Review

CSC - Security and Demarcation Fence Repair
Drumheller Institution
Drumheller, Alberta
Project No. R.049481.002

7 REVIEWED BY

Architectural

David Patsula, Area Design Manager, Architect AAA

Ph: (403) 292-4737

Fax: (403) 292-4886

Email: david.patsula@pwgsc.gc.ca

Civil

Ron Iverson, Civil Engineer, P.Eng.

Ph: (780) 497-3858

Fax: (780) 497-3842

Email: Ron.Iverson@pwgsc-tpsgc.gc.ca

- 1) General Instruction 1.3.2 - What is "the most recent CSC Technical Criteria" where can we find this?

Please see Addendum # 3. The required sections of the CSC Technical Criteria have been added to Appendix A.

- 2) For the purpose of tendering... Is all the work that is to be completed shown on Civil Drawings D-C01 through D-C14?

No. The civil drawings only make up part of the project scope of work. All of the items posted on the buyandsell.gc.ca site for this projects tender are also part of the project requirements.

- 3) Who is responsible for the testing costs of the MDS and FDS Systems?

The Institution does multiple tests daily. If the system is not working due to work completed by the Contractor, it will be the responsibility of the Contractor to work with the Institution, to make the required changes, to correct their work to have a working MDS and FDS system prior to final acceptance of the project. Institution contact information is in the specifications.

- 4) Is a pre-construction test also required to ensure the systems are working correctly prior to the start of construction?

that is up to the contractor but it is tested multiple times per day by the Institution.

- 5) Is there an as-built drawing available to view for the existing anti-tunneling wall?

No but the old specification stated that the anti-tunneling wall was to be built between posts on the interior perimeter fence with the deptch to be determined by local soil conditions but to be a minimum depth of 900mm. Due to not having the existing as built drawings for the existing anti-tunneling wall and for pricing purposes, presume that the existing anti-tunneling wall is 2135 mm in depth.

- 6) Drawing D-C01 Concertina Notes 5.2 - Is a Second concertina wire to be installed around the inner perimeter fence? It is not noted on any of the civil drawings.

Addendum 3 Appendix A shows where two concertina wire are required on interior fencing as per the CSC Technical Criteria.

- 7) Section 09 97 19 Painting Exterior Metal - There are no noted areas on the Civil Drawings that refer to Painting being required. For the purpose of tendering... is Painting only required as a unit rate in the event it is added after award?**[LUMSDENS] As per Addendum 3, neither the inner nor outer fences need to be painted black. Welds to fix post splits etc shall be covered with a suitable rust inhibitor/protective coating approximating the color of the welded component; i.e. typically either galvanized or black.**

- 8) Drawing D-C02 Chain Link Fencing and Tie Repairs - Note 2, Are we only including 500 new hog rings in the Tender Lump Sum Bid?

The number of new hog rings has been removed and Note 2 is to have the line "For pricing purposes provide cost for 500 new hog rings." REMOVED from the scope. The Contractor is to complete the scope of Note 2 without a stipulation on the number of hog rings to quote to provide and install these items as required to complete the scope of work.

- 9) Fence Hog Rings – Can 9 gauge galvanized Hog Rings be substituted in place of the stainless steel hog rings?

No. Stainless steel hog rings are not to be substituted with another product.

- 10) Drawing D-C04 Note 13 "Refer to Detail 1/D-C10 for depth required" – Should this read Detail 2?

No. These notes and details are correct.

- 11) The Tender is a Lump Sum Bid, Is the Unit Rate Pricing Table only used for the purpose of additional and deletions post-tender?

Addendum # 3 has removed the Unit Rate Pricing Table. This project is to be bid as a Lump Sum Project.

- 12) Will the Institute be responsible for security during a "Breach" while the fence is being worked on?

Yes and No. The Contractor is responsible for making sure he follows the specs and only removes up to a certain length of perimeter fencing at a time and has it replaced by the end of the day it is removed. While all breaches of the perimeter fence are being worked on, the Institution will provide Guards during working hours to "man the fence" with the Commissionaire Escort.

- 13) How much of the fence can be opened during construction at one time?

Please read Section 01 14 00 subsection 1.2.2. Whatever length you can replace that same day before leaving the work site.

- 14) Are new control arms required for the entire outer perimeter fence?

The drawings are clear where new control arms have been noted to be replaced but it is the intention of this project to replace all damaged control arms. Control arms are to be replaced if found damaged to the point where it will not meet structural requirements of a new control arm.

- 15) If the PA cables have to be extended to enable the posts in the corners to be straightened, who is responsible for the costs and testing?

"The contractor shall to the extent reasonably practical, carry out the work in a manner that will avoid or minimize interference with the existing fence electrical and electronic security systems. Where possible, any required extensions of the PA or other cables should be accomplished first by checking for existing loops in the wiring that can be opened up or shortened. If the required extension cannot be so accomplished, the affected cable will have to be completely replaced between adjacent Junction boxes. (Permanent splices to extend cables will not be permitted). In event any work affecting the fence's communication or other electronic security systems is required, the contractor shall co-ordinate work with the institution and utilize the services of an electrical sub-contractor with experience with such systems."

- 16) Can we get any available Geo-technical or soil test holes reports for the prison, original or subsequent?

We do not have any available Geo-technical reports from around the fencing.

- 17) Is the only painting that is required for the Tender, "touch up welds with Galv-a-lum paint"?

Please refer to the answer to question 7 regarding painting.

- 18) Drawing D-C11 Detail 5 – The existing leaning posts are a 63mm diameter and you are asking for a 73mm top rail, is this correct?

According to D-C11 the new top rail is to be 73mm. Where the contractor obtained the existing post size is unknown and will have to be confirmed by the contractor.

- 19) Drawing D-C11 Detail 3 revision c says "Galvanized steel control arms at 45 degree" - Does this mean that if any existing control arms are not 45 degree they will need to be replaced? Or that it only applies to where new control arms are required for tender proposes?

The 45 degree arm detail is to be followed for all new installations except in situations where two control arms are required as per the CSC Technical Criteria. See the answer to question 14. The final result is they should all be of the same structural integrity.

20) Are both the inner and outer perimeter to be re-painted?

Please see the answer to question # 7.

21) Section 32 31 13 Note 7. "See drawings for chain replacement for gates." No drawing has been provided.

Addendum # 3 now has the CSC Technical Criteria but keep in mind that your scope of work (what needs to be worked on and when) is listed in the D-C## drawings and notes.

22) Any gate operator? Does it have any specifications to follow other than a "manual operation in case of power outage"

Please note the answer to question # 21.

23) Drawing D-C10 Detail 1 revision c shows the new anti-tunneling wall to be 2135 mm in depth. Is this correct?

Yes.

24) What is the depth of the existing anti-tunneling wall?

Please see the answer to question # 5.